











str/nds

S 23

			50Hz	60Hz
	Ø 23 mm		105-210 350-700 445-890 1460-2900	130-260 420-840 535-1070 1740-3480
	130 mm		0,65/0,90 kW	0,80/1,10 kW
	M16 / M20			
	MK/MT 2			
	500 x 400 mm			



185

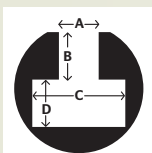

A 14,5 +/- 0,8 mm
B 13 mm
C 26 mm
D 12 mm

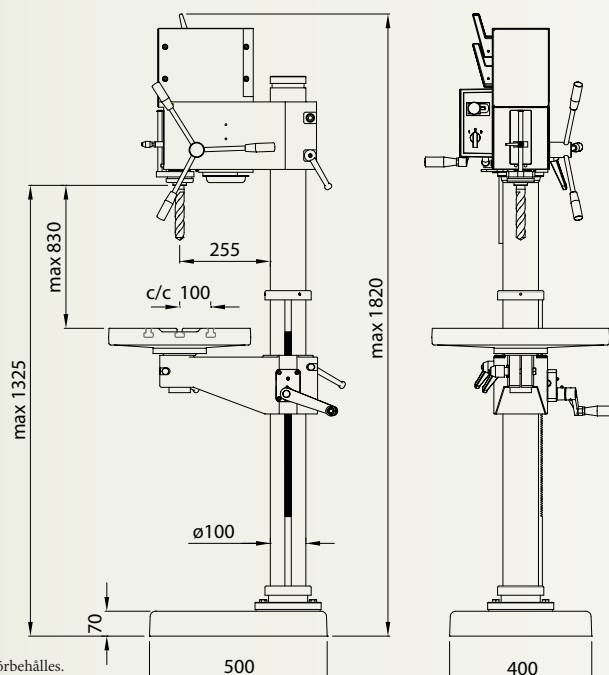

Rätt till ändringar av tekniska data utan föregående meddelande förbehålles.
We reserve the right to make modifications without prior warning.
Das recht auf Änderung der vorstehenden Daten behalten wir uns vor.

Tillbehör S 23

Spare parts/Zubehör

strands



T25095



T25100



T25003

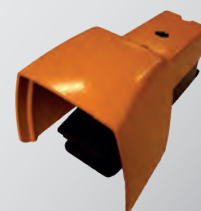

T25009



T25010

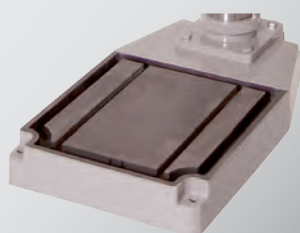

T25011



T25012



T25021



T23040 0-13 mm



T23041 3-16 mm

Std EU



T25014 + T25052

MSC
machinery scandinavia
MADE IN SWEDEN











ROSENFORS
MADE IN SWEDEN

Machinery Scandinavia AB
577 97 Rosenfors, Sweden
Tel +46 495 49 700
E-mail: sales@mscab.se
www.strandsmachinery.com



str/nds

S 23 B

		50Hz		60Hz	
	Ø 23 mm		105-210 350-700 445-890 1460-2900	130-260 420-840 535-1070 1740-3480	
	130 mm		0,65/0,90 kW	0,80/1,10 kW	
	M16 / M20				
	MK/MT 2				
	500 x 400 mm				



120

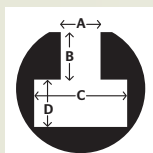

A 14,5 +/- 0,8 mm
B 13 mm
C 26 mm
D 12 mm

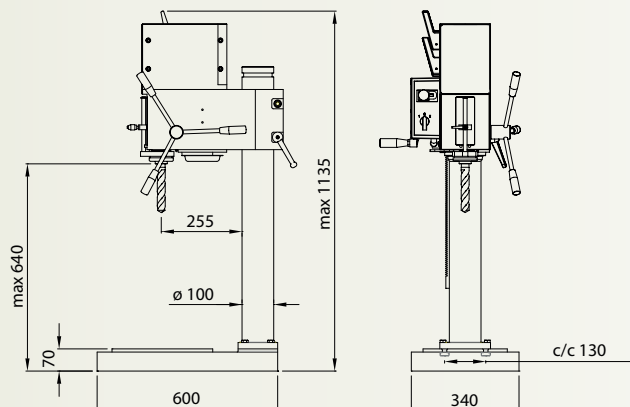

Tillbehör S 23 B

Spare parts/Zubehör

strands



T25095



T25100



T25B03

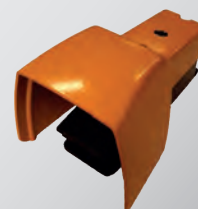

T25009



T25010



T25012



T25021



T23040 0-13 mm



T23041 3-16 mm

Std EU



T25014 + T25052

MSC
machinery scandinavia
MADE IN SWEDEN

ROSENFOR'S
MADE IN SWEDEN

Machinery Scandinavia AB
577 97 Rosenfors, Sweden
Tel +46 495 49 700
E-mail: sales@mscab.se
www.strandsmachinery.com



str/nds

S 25

		50Hz		60Hz	
	Ø 25 / 28 mm		105-210 350-700 445-890 1460-2900	130-260 420-840 535-1070 1740-3480	
	130 mm		0,65/0,90 kW	0,80/1,10 kW	
	M16 / M20				
	MK 3				
	500 x 400 mm				



185

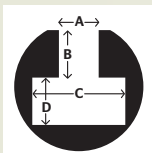

A 14,5 +/- 0,8 mm
B 13 mm
C 26 mm
D 12 mm

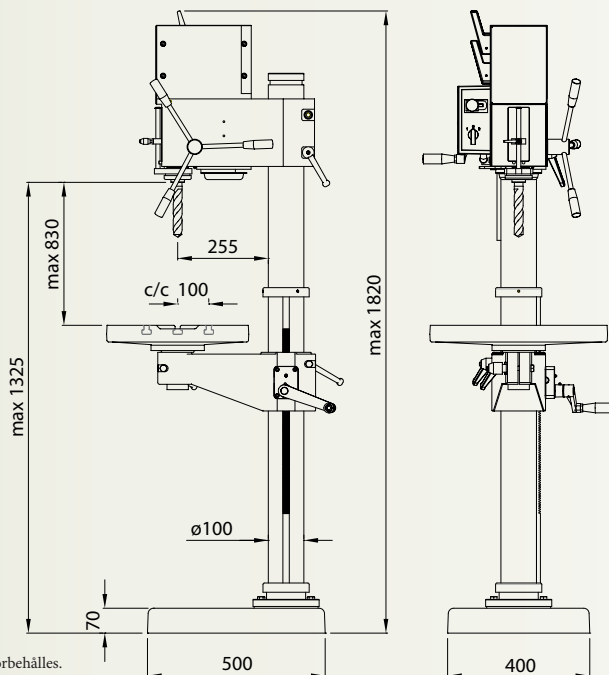

Rätt till ändringar av tekniska data utan föregående meddelande förbehålles.
We reserve the right to make modifications without prior warning.
Das recht auf Änderung der vorstehenden Daten behalten wir uns vor.

Tillbehör S 25

Spare parts/Zubehör

strands



T25095



T25000



T25003

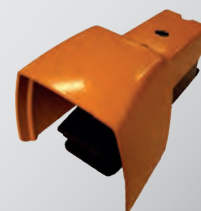

T25009



T25010

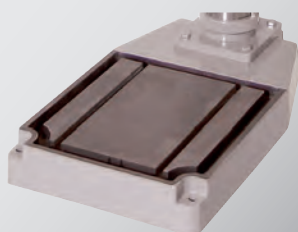

T25011



T25012

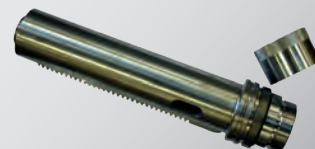

T25013



T25021



T25U42



T30040 0-13 mm



T30041 3-16 mm

Std EU



T25014 + T25052

MSC
machinery scandinavia
MADE IN SWEDEN









ROSENFORNS
MADE IN SWEDEN

Machinery Scandinavia AB
577 97 Rosenfors, Sweden
Tel +46 495 49 700
E-mail: sales@mscab.se
www.strandsmachinery.com



str/nds

S 25 B

			50Hz	60Hz
				Ø 25 / 28 mm
	130 mm		0,65/0,90 kW	0,80/1,10 kW
	M16 / M20			
	MK 3			
	500 x 400 mm			



120

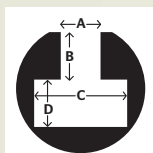

A 14,5 +/- 0,8 mm
 B 13 mm
 C 26 mm
 D 12 mm

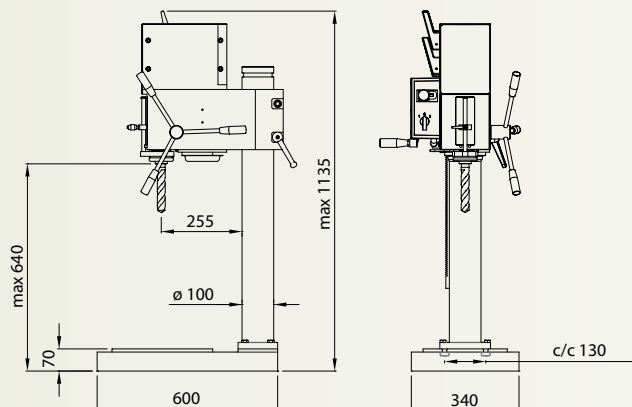

Tillbehör S 25 B

Spare parts/Zubehör

strands



T25095



T25000



T25B03

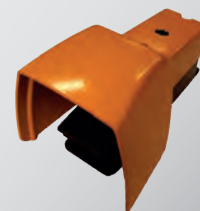

T25009



T25010



T25012

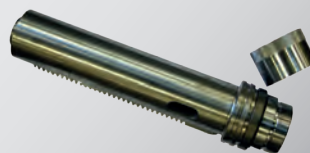

T25013



T25021

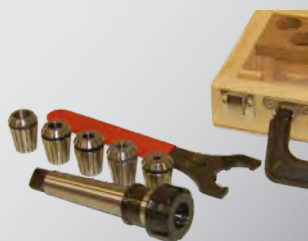

T25U42

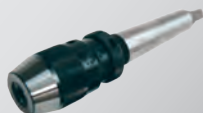

T30040

0-13 mm

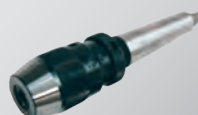

T30041

3-16 mm



Std EU

T25014 + T25052

MSC
machinery scandinavia
MADE IN SWEDEN

ROSENFORS
MADE IN SWEDEN

Machinery Scandinavia AB
577 97 Rosenfors, Sweden
Tel +46 495 49 700
E-mail: sales@mscab.se
www.strandsmachinery.com



str/nds

S 25 B M

	Ø 25 / 28 mm		50Hz 105-210 350-700 445-890 1450-2900	60Hz 130-260 420-840 535-1070 1740-3480
	130 mm		0,65/0,90 kW	0,80/1,10 kW
	M16 / M20		mm/r 0,10 0,15 0,22 0,30	inch/r 0,004 0,006 0,009 0,012
	MK 3			
	500 x 400 mm			



130

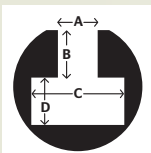

A 14,5 +/- 0,8 mm
 B 13 mm
 C 26 mm
 D 12 mm

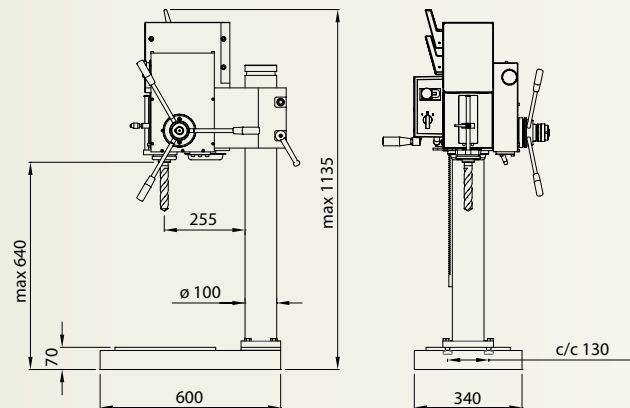

Tillbehör S 25 B M

Spare parts/Zubehör

strands



T25095



T25000



T25B03

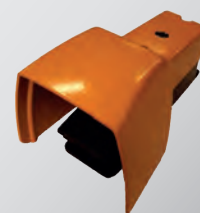

T25009



T25010



T25012

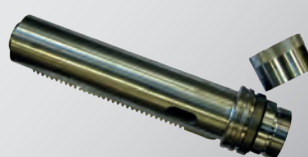

T25013



T25021

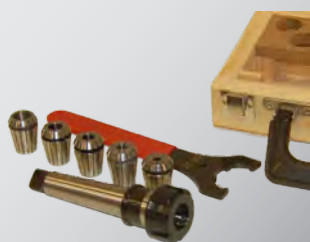

T25U42



T30040 0-13 mm



T30041 3-16 mm



Std EU

T25014 + T25052

MSC
machinery scandinavia
MADE IN SWEDEN

ROSENFORS
MADE IN SWEDEN

Machinery Scandinavia AB
577 97 Rosenfors, Sweden
Tel +46 495 49 700
E-mail: sales@mscab.se
www.strandsmachinery.com



str/nds

S 25 M

	Ø 25 / 28 mm		50Hz	60Hz
			105-210 350-700 445-890 1460-2900	130-260 420-840 535-1070 1740-3480
	130 mm		0,65/0,90 kW	0,80/1,10 kW
	M16 / M20		mm/r	inch/r
			0,10 0,15 0,22 0,30	0,004 0,006 0,009 0,012
	MK 3			
	500 x 400 mm			



195

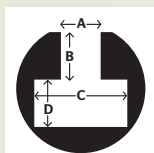

A 14,5 +/- 0,8 mm
B 13 mm
C 26 mm
D 12 mm

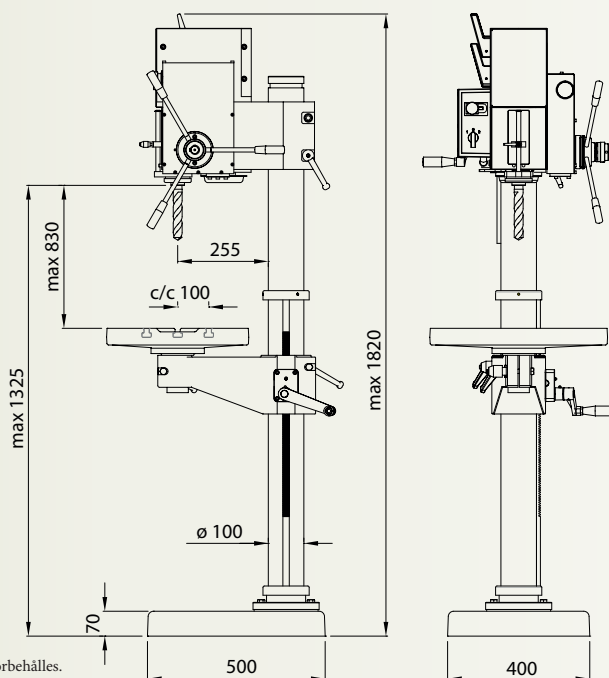

Rätt till ändringar av tekniska data utan föregående meddelande förbehålles.
We reserve the right to make modifications without prior warning.
Das recht auf Änderung der vorstehenden Daten behalten wir uns vor.

Tillbehör S 25 M

Spare parts/Zubehör

strands



T25095



T25000



T25003

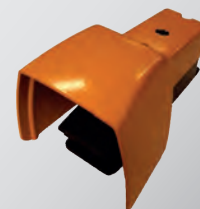

T25009



T25010

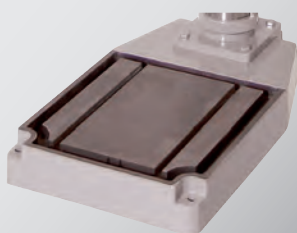

T25011



T25012

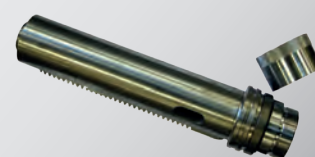

T25013



T25021



T25U42



T30040 0-13 mm



T30041 3-16 mm

Std EU



T25014 + T25052

MSC
machinery scandinavia
MADE IN SWEDEN

ROSENFORS
MADE IN SWEDEN

Machinery Scandinavia AB
577 97 Rosenfors, Sweden
Tel +46 495 49 700
E-mail: sales@mscab.se
www.strandsmachinery.com



str/nds

S 25 T

	Ø 25 / 28 mm		50Hz 105-210 350-700 445-890 1460-2900	60Hz 130-260 420-840 535-1070 1740-3480
	130 mm		0,75/0,95 kW	
	M16 / M20			
	MK 3			
	500 x 400 mm			



195

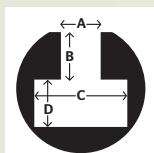

A 14,5 +/- 0,8 mm
B 13 mm
C 26 mm
D 12 mm

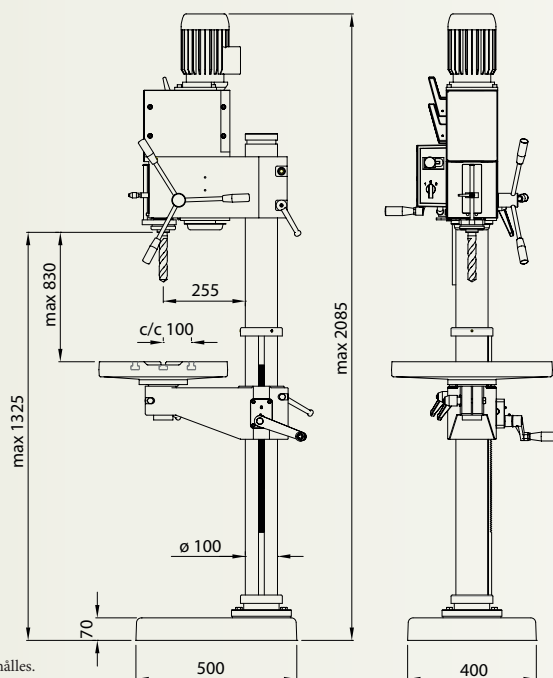

Tillbehör S 25 T

Spare parts/Zubehör

strands



T25095



T25000



T25003

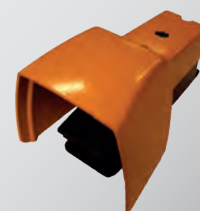

T25009



T25010

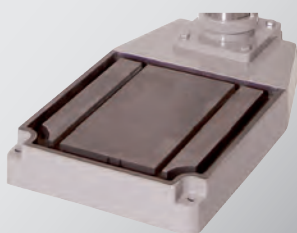

T25011



T25012

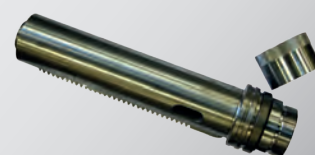

T25013



T25021



T25U42



T30040 0-13 mm



T30041 3-16 mm

Std EU



T25014 + T25052

MSC
machinery scandinavia
MADE IN SWEDEN

ROSENFORS
MADE IN SWEDEN

Machinery Scandinavia AB
577 97 Rosenfors, Sweden
Tel +46 495 49 700
E-mail: sales@mscab.se
www.strandsmachinery.com



str/nds

S 25 T - 1 ~

			50Hz	60Hz
			105-210 350-700 445-890 1460-2900	130-260 420-840 535-1070 1740-3480
	Ø 25 / 28 mm		0,55/0,75 kW	
	130 mm			
	M16 / M20			
	MK 3			
	500 x 400 mm			



195

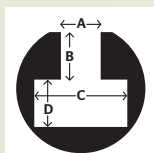

A 14,5 +/- 0,8 mm
B 13 mm
C 26 mm
D 12 mm

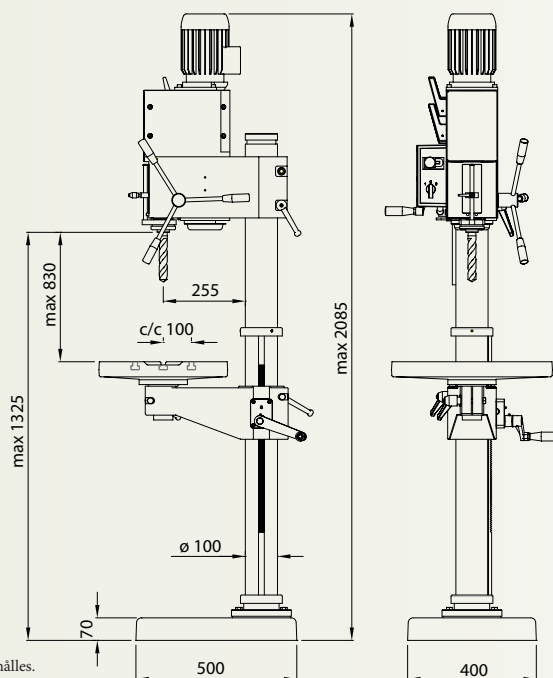

Rätt till ändringar av tekniska data utan föregående meddelande förbehålles.
We reserve the right to make modifications without prior warning.
Das recht auf Änderung der vorstehenden Daten behalten wir uns vor.

Tillbehör S 25 T - 1 ~

Spare parts/Zubehör

strands

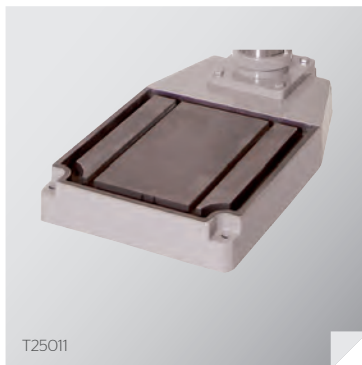

MSC
machinery scandinavia
MADE IN SWEDEN

ROSENFORSS
MADE IN SWEDEN

Machinery Scandinavia AB
577 97 Rosenfors, Sweden
Tel +46 495 49 700
E-mail: sales@mscab.se
www.strandsmachinery.com