



2011

Coolant Nozzles

MAXIMIZING MACHINE TOOL PRODUCTIVITY



QPM Products Corporation

#2 - 740 Fairweather Road, Vernon, B.C. Canada V1T 8T9

Phone: 1 800 711-9933

Fax: 1 800 211-3366

(250) 549-2320

(250) 549-2460

email: sales@qpmproducts.com • website: www.qpmproducts.com



Coolant Delivery Solutions to Solve Your Production Headaches

Did you ever feel that the coolant system on your machine tools was added as an afterthought? Do you constantly have to improvise and modify nozzles just to get coolant to the tool tip? Are you afraid to run your machines unattended in case a coolant nozzle vibrates out of position and starts a “tool meltdown”? Does coolant seem to be spraying everywhere except where it’s supposed to be spraying? Do you constantly stop production to adjust coolant lines?

If you answered yes to any of these questions then you’re certainly not alone. It seems that almost every manufacturer faces these problems on a regular basis. Most CNC machine tools have a coolant delivery system designed to handle a limited range of applications. In the real world however, your setups can be extremely varied and are only limited by your imagination, so you need lots of options for getting coolant to the cutting edge. No single nozzle will work well for all applications.

That’s why we’ve engineered a wide range of coolant nozzle products to fit your machines. They are designed to meet the varied needs of manufacturers just like you. If you don’t see something in this catalog that will work for you, call us and we’ll work with you to solve your problem!

Choosing the Right Nozzle

Coolant performs several functions in the machining process, including lubrication, heat dissipation, corrosion prevention, chip control and dust suppression. Properly applied, it can help you achieve better tool life, higher production rates,

better finishes and improved accuracy. Improperly applied, it can actually be detrimental to the machining process.

The nozzle plays a critical role in the proper application of coolant. It must accurately direct an adequate flow with sufficient velocity directly at the tool/workpiece interface, and must resist vibration, swarf and inertial forces that could knock it out of alignment. All **QPM** nozzles are easy to aim, yet are rigid and compact to ensure reliable production.

The type of nozzle you choose will depend on your application and the type of coolant ports on your machine. Select the type of nozzle that fits your machine’s coolant ports and that is rated for your operating pressure. If you are not sure what pressure your coolant pump produces, it is often helpful to “tee in” a pressure gage near the pump outlet. Most people are surprised to find their pump puts out far less pressure than they thought.

Orifice Diameter

Choose an orifice size that matches your pump’s capacity. If the orifice is too big, the pressure will drop off with a resultant drop in coolant velocity. If too small, an inadequate amount of coolant will reach the tooltip.

To calculate the average coolant exit velocity (important in some grinding operations where it is often desirable to match or exceed the peripheral velocity of the wheel), refer to the formula on page 3. Choose an orifice size that produces sufficient backpressure to achieve the desired velocity. Refer to the table below for information regarding flow rates of various orifice sizes at different pressures.

ORIFICE DIAMETER (inches)	FLOW RATE (US gal./min.)													
	5 psi	10 psi	20 psi	30 psi	40 psi	60 psi	80 psi	100 psi	150 psi	200 psi	300 psi	500 psi	1000 psi	1500 psi
.040	.07	.10	.14	.17	.20	.26	.31	.35	.41	.46	.61	.88	1.2	1.4
.062	.19	.25	.37	.44	.51	.62	.73	.80	1.0	1.2	1.5	2.1	3.0	3.8
.086	.36	.51	.72	.85	1.0	1.2	1.5	1.7	2.0	2.3	2.8	3.7	5.2	6.3
.110	.64	.90	1.4	1.6	1.8	2.2	2.5	3.1	3.6	4.1	5.2	6.5	8.9	10.9
.160	1.4	2.0	2.8	3.5	4.0	4.8	5.6	6.2	7.6	9.1	10.8	14.0	19.8	24.3
.220	2.5	3.7	5.2	6.7	7.8	9.3	10.6	11.8	14.4	16.5	19.6	25.2	35.5	43.5

Note: Flow Rates are based on water at 68°F (20°C). Actual results will vary with fluid type, extension length and aiming angle.

Contents

Nozzle Extensions

Choose a nozzle extension that suits your application. Short projections are more compact and are less likely to be knocked out of position by swarf or vibration, while longer extensions are easier to aim, produce a more laminar flow and shoot farther. Some experimentation will be required to achieve the optimum setup.

A Word About Pumps

The most common coolant pump on CNC machine tools is a single-stage centrifugal pump. They are normally designed to move high volumes of water at low pressures (typically 3 - 20 psi). Multi-stage centrifugal pumps are capable of higher pressures (typically 20 - 200 psi) while still producing high flow rates. Positive displacement pumps are used for very high pressure applications (up to 2000 psi) and are generally used with small diameter orifices due to their lower flow rates. Contact us if you have any questions regarding pumps or pump manufacturers.

Calculating Coolant Velocity





























The average coolant exit velocity can be calculated using the following formula:

$$V = \frac{24.5 F}{d^2}$$

Average Exit Velocity ft./min. Flow Rate through Orifice in US gal./min. (see table on pg 2)

Orifice Diameter in inches

Example: Pump Pressure: 40 psi Orifice Diameter: .160"
 Flow Rate: 4.0 US gal./min.
 $V = \frac{24.5 \times 4.0}{.160^2} = \underline{3828 \text{ ft./min.}}$

	TurretJet4	FOR THREADED PORTS
	CapJet.....5	
	JetBolt6	
	PlugJet.....7	
	MillJet.....8	
	LockJet9	
	PressureMax..... 10-13	
	Compression Fittings..14	
	DualFit15	
	Spray Tips.....16	
	Extension Tubes17	FOR COPPER TUBE
	JetTube18	
	SweatJet.....19	MODULAR HOSE
	SwivelMax20,21	
	AL36022,23	FOR BALL-TYPE PORTS
	BrassBalls.....24	
	BlackEye25	
	BugEye.....26	FOR PRESS-FIT PORTS
	LolliPop.....27	
	TwinPop28	
	OddBall29	ACCESSORIES
	JiffyJet.....30	
	ScrewBall31	
	PrestoPort.....32	
	Check Valves32	
	Manifold.....33	
	Ball Valves33	
	ChuckPuck.....34	
	BorePlug35	



**FITS
NPT & BSPT
THREADS**

**RATED
TO
150 PSI
(10 BAR)**

Turret Jet™

You can choose
the orifice size and
extension to suit your
application!

New metric tapped
balls allow use with
Extension Tubes and
Spray Tips.



UNIVERSAL COOLANT NOZZLE FOR CNC MACHINES

- Converts any NPT or BSPT hole to a fully adjustable nozzle
- Hits any target above mounting plane
- Adjusts easily for accurate coolant placement
- Difficult to accidentally knock out of adjustment
- Choose larger orifices for maximum flow
- Choose smaller orifices when using multiple nozzles
- Choose tapped ball, if you need to quickly plug the orifice (setscrew included) or to use with **Extension Tubes** (page 17) or **Spray Tips** (page 16)
- Longer extensions are a breeze to aim and shoot farther, great for Machining Centers and CNC Multi-Axis Grinders
- Choose short extensions for tight spaces like CNC Turning Centers and Screw Machines

DIMENSIONS IN INCHES (except as noted)

Part No.	Thread Size "E"	Orifice Dia. "d"	Extension "L"	A	B	C	F	Pkg Qty
TJ01605	1/16 NPT/BSPT	.086	.25	.69	.5	.44	.31	5
TJ01610	1/16 NPT/BSPT	.086	.50	.69	.5	.44	.31	5
TJ01615	1/16 NPT/BSPT	.086	1.25	.69	.5	.44	.31	5
TJ01620	1/16 NPT/BSPT	.11	0	.69	.5	.44	.31	5
TJ01625	1/16 NPT/BSPT	.11	.25	.69	.5	.44	.31	5
TJ01630	1/16 NPT/BSPT	.11	.5	.69	.5	.44	.31	5
TJ01635	1/16 NPT/BSPT	.11	1.25	.69	.5	.44	.31	5
TJ01640	1/16 NPT/BSPT	.16	0	.69	.5	.44	.31	5
TJ01645	1/16 NPT/BSPT	M4 x .7	0	.69	.5	.44	.31	5
TJ00100	1/8 NPT/BSPT	.11	0	.82	.63	.50	.38	5
TJ00130	1/8 NPT/BSPT	.11	.25	.82	.63	.50	.38	5
TJ00131	1/8 NPT/BSPT	.11	.50	.82	.63	.50	.38	5
TJ00132	1/8 NPT/BSPT	.11	1.25	.82	.63	.50	.38	5
TJ00134	1/8 NPT/BSPT	.16	0	.82	.63	.50	.38	5
TJ00136	1/8 NPT/BSPT	.16	.50	.82	.63	.50	.38	5
TJ00138	1/8 NPT/BSPT	.16	1.25	.82	.63	.50	.38	5
TJ00141	1/8 NPT/BSPT	M5 x .8	0	.82	.63	.50	.38	5
TJ00142	1/4 NPT/BSPT	.11	0	.94	.75	.63	.44	5
TJ00144	1/4 NPT/BSPT	.11	.25	.94	.75	.63	.44	5
TJ00145	1/4 NPT/BSPT	.11	.50	.94	.75	.63	.44	5
TJ00146	1/4 NPT/BSPT	.11	1.25	.94	.75	.63	.44	5
TJ00101	1/4 NPT/BSPT	.16	0	.94	.75	.63	.44	5
TJ00148	1/4 NPT/BSPT	.16	.50	.94	.75	.63	.44	5
TJ00150	1/4 NPT/BSPT	.16	1.25	.94	.75	.63	.44	5
TJ00153	1/4 NPT/BSPT	M5 x .8	0	.94	.75	.63	.44	5
TJ00166	3/8 NPT/BSPT	.11	0	1.13	.88	.75	.50	5
TJ00170	3/8 NPT/BSPT	.11	1.25	1.13	.88	.75	.50	5
TJ00154	3/8 NPT/BSPT	.16	0	1.13	.88	.75	.50	5
TJ00156	3/8 NPT/BSPT	.16	.50	1.13	.88	.75	.50	5
TJ00158	3/8 NPT/BSPT	.16	1.25	1.13	.88	.75	.50	5
TJ00102	3/8 NPT/BSPT	.22	0	1.13	.88	.75	.50	5
TJ00160	3/8 NPT/BSPT	.22	.50	1.13	.88	.75	.50	5
TJ00162	3/8 NPT/BSPT	.22	1.25	1.13	.88	.75	.50	5
TJ00165	3/8 NPT/BSPT	M6 x 1.0	0	1.13	.88	.75	.50	5

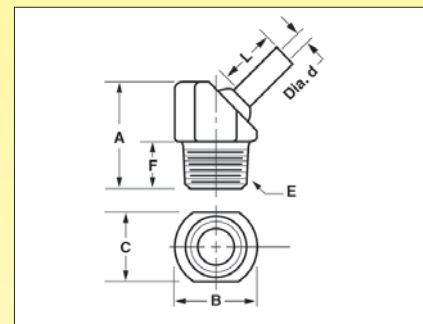

TurretJets are ideal for CNC Turning Centers, Machining Centers, Screw Machines and CNC Multi-Axis Grinders.

Material: Body: Acetal **Ball & Extension:** Stainless Steel
Maximum Pressure: 150 PSI (10 bar) **Maximum Operating Temperature:** 160°F (70°C)

WE RESERVE THE RIGHT TO CHANGE SPECIFICATIONS WITHOUT NOTICE OR OBLIGATION.



CapJet™

**FITS
NPT & BSPT
PIPE
NIPPLES**

**RATED
TO
150 PSI
(10 BAR)**

**New metric tapped
balls allow use with
Extension Tubes and
Spray Tips.**



UNIVERSAL CAP-TYPE COOLANT NOZZLE

- Screws onto any NPT or BSPT pipe nipple just like a pipe cap
- Same great features as the TurretJet, except with female pipe thread
- Ideal for high production, dedicated machine tools with rigid coolant piping
- Choose orifice size and nozzle extension to suit your application
- Choose short extensions for tight spaces and where stringy swarf is a problem
- Long extensions make aiming a breeze and shoot farther
- Choose larger orifices for maximum flow ■ Choose smaller orifices when using multiple nozzles
- Choose tapped ball if you need to quickly plug the orifice (setscrew included) or to use with

Extension Tubes (page 17) or **Spray Tips** (page 16)

DIMENSIONS IN INCHES (except as noted)

Part No.	Thread Size "E"	Orifice Dia. "d"	Extension "L"	A	B	C	Pkg Qty
CJ07510	1/8 NPT/BSPT	.11	0	.82	.63	.50	5
CJ07512	1/8 NPT/BSPT	.11	.25	.82	.63	.50	5
CJ07513	1/8 NPT/BSPT	.11	.50	.82	.63	.50	5
CJ07514	1/8 NPT/BSPT	.11	1.25	.82	.63	.50	5
CJ07516	1/8 NPT/BSPT	.16	0	.82	.63	.50	5
CJ07518	1/8 NPT/BSPT	.16	.50	.82	.63	.50	5
CJ07520	1/8 NPT/BSPT	.16	1.25	.82	.63	.50	5
CJ07523	1/8 NPT/BSPT	M5 x .8	0	.82	.63	.50	5
CJ07524	1/4 NPT/BSPT	.11	0	.94	.75	.63	5
CJ07526	1/4 NPT/BSPT	.11	.25	.94	.75	.63	5
CJ07527	1/4 NPT/BSPT	.11	.50	.94	.75	.63	5
CJ07528	1/4 NPT/BSPT	.11	1.25	.94	.75	.63	5
CJ07530	1/4 NPT/BSPT	.16	0	.94	.75	.63	5
CJ07532	1/4 NPT/BSPT	.16	.50	.94	.75	.63	5
CJ07534	1/4 NPT/BSPT	.16	1.25	.94	.75	.63	5
CJ07537	1/4 NPT/BSPT	M5 x .8	0	.94	.75	.63	5
CJ07560	3/8 NPT/BSPT	.11	0	1.13	.88	.75	5
CJ07538	3/8 NPT/BSPT	.16	0	1.13	.88	.75	5
CJ07540	3/8 NPT/BSPT	.16	.50	1.13	.88	.75	5
CJ07542	3/8 NPT/BSPT	.16	1.25	1.13	.88	.75	5
CJ07544	3/8 NPT/BSPT	.22	0	1.13	.88	.75	5
CJ07546	3/8 NPT/BSPT	.22	.50	1.13	.88	.75	5
CJ07548	3/8 NPT/BSPT	.22	1.25	1.13	.88	.75	5
CJ07552	3/8 NPT/BSPT	M6 x 1.0	0	1.13	.88	.75	5

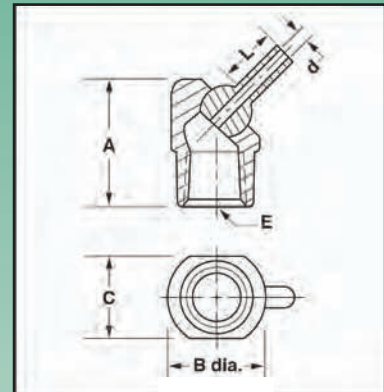

CapJet shown installed on end of threaded pipe.

Material: Body: Acetal
Ball & Extension: Stainless Steel
Maximum Pressure: 150 PSI (10 bar)
Maximum Operating Temperature: 160°F (70°C)



DIMENSIONS IN INCHES (except as noted)

Part No.	Thread Size "E"	Orifice Dia. "d"	Extension "L"	B (Hex)	A	F	Pkg Qty
JB09005	M10 x 1.25	.11	0	17mm	.41	.36	5
JB09010	M10 x 1.25	.11	.25	17mm	.41	.36	5
JB09013	M10 x 1.25	.11	.50	17mm	.41	.36	5
JB09015	M10 x 1.25	.11	1.25	17mm	.41	.36	5
JB09020	M10 x 1.25	.16	0	17mm	.41	.36	5
JB09025	M10 x 1.25	.16	.50	17mm	.41	.36	5
JB09030	M10 x 1.25	.16	1.25	17mm	.41	.36	5
JB09033	M10 x 1.25	M5 x .8	0	17mm	.41	.36	5
JB09035	M10 x 1.5	.11	0	17mm	.41	.36	5
JB09040	M10 x 1.5	.11	.25	17mm	.41	.36	5
JB09043	M10 x 1.5	.11	.50	17mm	.41	.36	5
JB09045	M10 x 1.5	.11	1.25	17mm	.41	.36	5
JB09050	M10 x 1.5	.16	0	17mm	.41	.36	5
JB09055	M10 x 1.5	.16	.50	17mm	.41	.36	5
JB09060	M10 x 1.5	.16	1.25	17mm	.41	.36	5
JB09063	M10 x 1.5	M5 x .8	0	17mm	.41	.36	5
JB09065	M12 x 1.75	.11	0	17mm	.41	.36	5
JB09070	M12 x 1.75	.11	.25	17mm	.41	.36	5
JB09073	M12 x 1.75	.11	.50	17mm	.41	.36	5
JB09075	M12 x 1.75	.11	1.25	17mm	.41	.36	5
JB09080	M12 x 1.75	.16	0	17mm	.41	.36	5
JB09085	M12 x 1.75	.16	.50	17mm	.41	.36	5
JB09090	M12 x 1.75	.16	1.25	17mm	.41	.36	5
JB09093	M12 x 1.75	M5 x .8	0	17mm	.41	.36	5
JB09095	M20 x 1.5	.16	.75	24mm	.60	.50	5
JB09094	M20 x 1.5	.16	1.50	24mm	.60	.50	5
JB09096	M20 x 1.5	.22	.75	24mm	.60	.50	5
JB09098	M20 x 1.5	.22	1.50	24mm	.60	.50	5
JB09097	M20 x 1.5	.28	.75	24mm	.60	.50	5
JB09099	M20 x 1.5	.28	1.50	24mm	.60	.50	5
JB09100	1/8 NPT/BSPT	.11	0	17mm	.41	.39	5
JB09130	1/8 NPT/BSPT	.11	.25	17mm	.41	.39	5
JB09131	1/8 NPT/BSPT	.11	.50	17mm	.41	.39	5
JB09132	1/8 NPT/BSPT	.11	1.25	17mm	.41	.39	5
JB09134	1/8 NPT/BSPT	.16	0	17mm	.41	.39	5
JB09136	1/8 NPT/BSPT	.16	.50	17mm	.41	.39	5
JB09138	1/8 NPT/BSPT	.16	1.25	17mm	.41	.39	5
JB09141	1/8 NPT/BSPT	M5 x .8	0	17mm	.41	.39	5
JB09142	1/4 NPT/BSPT	.11	0	17mm	.41	.50	5
JB09144	1/4 NPT/BSPT	.11	.25	17mm	.41	.50	5
JB09145	1/4 NPT/BSPT	.11	.50	17mm	.41	.50	5
JB09146	1/4 NPT/BSPT	.11	1.25	17mm	.41	.50	5
JB09101	1/4 NPT/BSPT	.16	0	17mm	.41	.50	5
JB09148	1/4 NPT/BSPT	.16	.50	17mm	.41	.50	5
JB09150	1/4 NPT/BSPT	.16	1.25	17mm	.41	.50	5
JB09153	1/4 NPT/BSPT	M5 x .8	0	17mm	.41	.50	5
JB09166	3/8 NPT/BSPT	.11	0	17mm	.41	.50	5
JB09168	3/8 NPT/BSPT	.11	.50	17mm	.41	.50	5
JB09170	3/8 NPT/BSPT	.11	1.25	17mm	.41	.50	5
JB09154	3/8 NPT/BSPT	.16	0	17mm	.41	.50	5
JB09156	3/8 NPT/BSPT	.16	.50	17mm	.41	.50	5
JB09158	3/8 NPT/BSPT	.16	1.25	17mm	.41	.50	5
JB09102	3/8 NPT/BSPT	.22	0	17mm	.41	.50	5
JB09160	3/8 NPT/BSPT	.22	.50	17mm	.41	.50	5
JB09162	3/8 NPT/BSPT	.22	1.25	17mm	.41	.50	5
JB09165	3/8 NPT/BSPT	M6 x 1.0	0	17mm	.41	.50	5

Jet Bolt™



SCREW-IN, BOLT TYPE COOLANT NOZZLE

- Screws into a threaded coolant port just like a bolt
- ±35 degrees of adjustment either side of centerline
- Rated to 150 PSI (10 bar)
- Sizes available to fit almost every machine or tool holder
- Choose the orifice diameter and projection length to suit your application
- Choose larger orifices for maximum flow
- Choose smaller orifices when using multiple nozzles
- Choose tapped ball if you need to quickly plug the orifice (setscrew included) or to use with **Extension Tubes** (page 17) or **SprayTips** (page 16)
- Short extensions are ideal for CNC lathes or vertical turning centers
- Long extensions are a breeze to aim and are perfect for horizontal machining centers

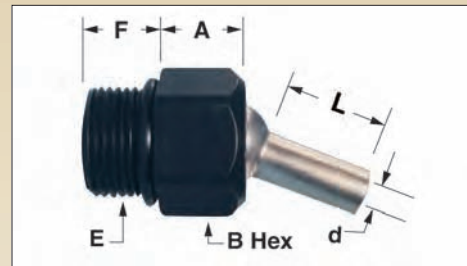

Material: Body: Acetal
Ball & Extension: Stainless Steel

Maximum Operating Temperature: 160°F (70°C)

Maximum Pressure: 150 PSI (10 bar)

**CONTACT
US FOR
CUSTOM
ORDERS**



Plug Jet™



SCREW-IN, FLUSH MOUNT COOLANT NOZZLE

- Screws into an NPT or BSPT hole just like a flush plug
- 35 degrees adjustment either side of centerline ■ Rated to 150 psi max
- Ideal for machining applications where nozzle projections must be minimized

DIMENSIONS IN INCHES

Part No.	Thread Size "E"	A	B(HEX)	C	Orifice Dia "d"	F(degrees)	Pkg Qty
PJ00510	1/8 NPT	.50	9/64	.12	.16	0-35	5
PJ00520	1/8 BSPT	.50	9/64	.12	.16	0-35	5
PJ00530	1/4 NPT/BSPT	.62	9/64	.15	.16	0-40	5
PJ00540	3/8 NPT/BSPT	.75	3/16	.18	.22	0-40	5

Material: Body - Acetal Ball - Stainless Steel

Maximum Operating Temperature: 160°F (70°C)

Maximum Pressure: 150 PSI (10 bar)

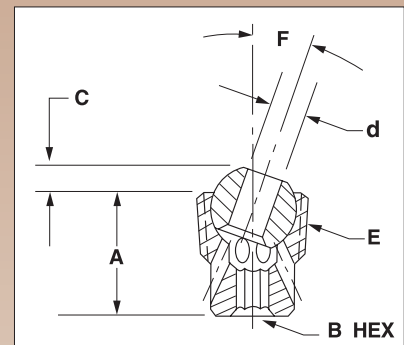

Simply insert the end of allen wrench (included) into the hole in the stainless ball until it engages the hex hole in the acetal body, then tighten the **PlugJet** into the tapped hole until the body is flush.



Mill Jet™



COOLANT NOZZLE FOR VERTICAL & HORIZONTAL MACHINING CENTERS

- Adjusts from full shutoff to fine fan spray to direct stream
- Aimable from zero to 90° with 360° sweep
- Stays put (doesn't vibrate out of place)
- No interference problems with clamps, fixtures or swarf
- Fits NPT and BSPT threads
- Rated to 100 psi (6.7 bar) maximum

DIMENSIONS IN INCHES

Part No.	Thread Size "E"	B	C	D (Degrees)	A	F	Pkg Qty
MJ03010	1/8 NPT/BSPT	1.50	1.70	0-90	.44	.625	2
MJ00117	1/4 NPT/BSPT	1.50	1.70	0-90	.44	.625	2

– Recommended coolant filtration - 100 microns –

Material: Acetal **Maximum Pressure:** 100 PSI (6.7 bar)
Maximum Operating Temperature: 160°F (70°C)

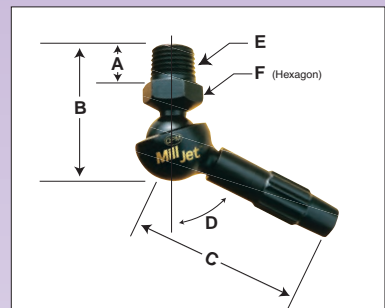

MillJets shown in use at various angles and spray widths.

MillJets shown installed on Vertical Machining Center showing wide and narrow spray.



**FITS
NPT & BSPT
THREADS**

**RATED
TO
1500 PSI
(100 BAR)**

LockJet™

LOCKABLE HIGH PRESSURE COOLANT NOZZLE



- Aimable and lockable
- Fits NPT and BSPT ports
- Ideal for applications where the nozzle could get bumped or knocked out of position
- Rated to 1500psi (100 bar)
- Easily interchangeable balls
- Choose the orifice and extension length to suit your application
- Available with bendable copper extension tubes

DIMENSIONS IN INCHES (except as noted)

Configuration (Complete Nozzle)	Size "E"	Part No. Complete Nozzle*	Pkg. Qty.	Orifice Dia. "d"	Extension "L"	"F" max (degrees)	Part No. Ball Only	Pkg. Qty.	Configuration (Ball Only)
	1/8 NPT/BSPT	LJ18110	5	.062	.25	33°	SSB23310	5	
		LJ18120	5	.062	1.25	28°	SSB23320	5	
		LJ18130	5	.086	.25	33°	SSB23330	5	
		LJ18140	5	.086	1.25	28°	SSB23340	5	
		LJ18150	5	.117	.50	33°	SSB23350	5	
		LJ18160	5	.117	1.25	28°	SSB23360	5	
		LJ18165	5	.125	6.0	28°	LP05526	5	
		LJ18170	5	.160	.50	28°	SSB23370	5	
		LJ18180	5	.160	1.25	28°	SSB23380	5	
	1/4 NPT/BSPT	LJ18210	5	.062	.38	33°	SSB23410	5	
		LJ18220	5	.062	1.25	33°	SSB23420	5	
		LJ18230	5	.086	.38	33°	SSB23430	5	
		LJ18235	5	.086	1.25	33°	SSB23435	5	
		LJ18240	5	.117	.50	33°	SSB23440	5	
		LJ18245	5	.117	1.25	33°	SSB23445	5	
		LJ18255	5	.125	6.0	33°	LP05506	5	
		LJ18260	5	.160	.50	33°	SSB23460	5	
		LJ18265	5	.160	1.25	33°	SSB23465	5	
		LJ18270	5	.220	.50	27°	SSB23470	5	
LJ18275	5	.220	1.25	27°	SSB23475	5			
	3/8 NPT/BSPT	LJ18305	5	.125	6.0	38°	LP05514	5	
		LJ18310	5	.160	.75	33°	SSB23510	5	
		LJ18320	5	.160	1.50	33°	SSB23520	5	
		LJ18330	5	.187	6.0	33°	LP05516	5	
		LJ18340	5	.220	.75	27°	SSB23540	5	
		LJ18350	5	.220	1.50	27°	SSB23550	5	
		LJ18360	5	.280	.75	23°	SSB23560	5	
		LJ18370	5	.280	1.50	23°	SSB23570	5	

* Complete nozzle part no. includes body, nut and ball.

Material: Body and Nut: Brass
SSB Balls: Stainless Steel
LP Balls: see page 27

Maximum Operating Temperature: 300°F (150°C)
Maximum Pressure: 1500 PSI (100bar)

WE RESERVE THE RIGHT TO CHANGE SPECIFICATIONS WITHOUT NOTICE OR OBLIGATION.



Pipe Sizes fit NPT & BSPT THREADS

RATED TO 1500 PSI (100 BAR)

Pressure Max™

Available in Brass or Stainless Steel



Available with extended spray tips to shoot farther

HIGH PRESSURE COOLANT NOZZLE FOR CNC MACHINES

- High velocity coolant stream increases productivity and tool life in machining and grinding operations
- Also ideal for low pressure applications where abrasive swarf is a problem
- Hits any target above mounting plane ■ Interchangeable spray tips available! ■ Easy to aim
- Choose short extensions for tight spaces like CNC Turning Centers and Screw Machines
- Choose stainless steel bodies when using cutting oils not compatible with brass (i.e. oils containing active sulphur)
- Choose brass bodies for economy ■ Pipe sizes fit NPT and BSPT threads ■ 1500 PSI Max (100 bar)
- Longer extensions are a breeze to aim and shoot farther, great for Machining Centers and CNC Multi-Axis Grinders



Short extensions aim easily with aiming tool (included).



Long extensions aim easily by hand.

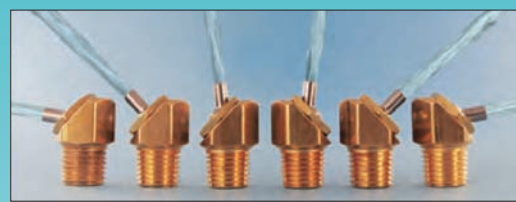

Angled outlet versions can hit just about any target above the mounting plane.



Interchangeable spray tips allow you to easily change orifice size and extension length to suit your application.



PressureMax Spray Tips can be mounted directly to toolholders or manifolds when space is limited, as in screw machine applications. See tables on following pages for port preparation detail.

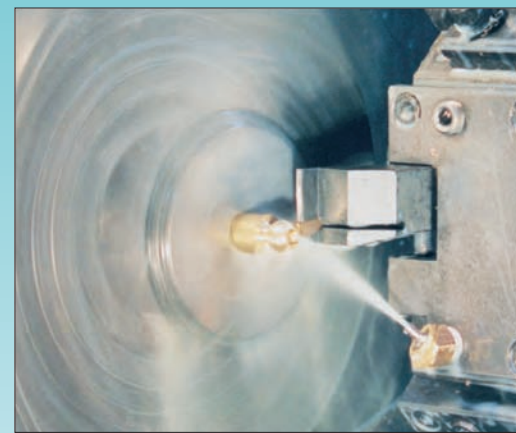

PressureMax nozzle shown in use on CNC turning center. High velocity coolant stream prolongs tool life and aids chip control.



Pressure Max™

Ordering Information: 1. Determine the port thread size required for your machine tool. 2. Choose nozzle body material (brass for general purpose, stainless steel when using cutting oils not compatible with cuprous alloys). 3. Determine orifice diameter required to match your pump's capacity at the desired pressure (refer to table on page 2). 4. Choose the extension length "L" to suit your application (longer extensions give more laminar flow, aim easily and shoot farther, while short extensions are ideal for tight spaces or where stringy swarf is a problem).

DIMENSIONS IN INCHES (except as noted)

Nominal Size: 5/16 - 24 UNF									
Nozzle & Port Detail	Mtl.	Part No. Complete Nozzle*	Pkg. Qty.	Orifice Dia. "d"	Extension "L"	"F" max (degrees)	Part No. Spray Tip Only	Pkg. Qty.	Spray Tip and Mating Port Detail
<p>5/16" - 24 UNF (tapered) 5/16 - 24 UNF x .30 DP. MIN.</p>	BRASS	PM07310	5	.040	.25	34°	PMT08410	5	
		PM07315	5	.062	0	40°	PMT08415	5	
		PM07320	5	.062	.25	34°	PMT08420	5	
		PM07330	5	.086	0	36°	PMT08430	5	
	STAINLESS	PM07312-SS	5	.040	.25	34°	PMT08412-SS	5	
		PM07316-SS	5	.062	0	40°	PMT08416-SS	5	
		PM07322-SS	5	.062	.25	34°	PMT08422-SS	5	
		PM07332-SS	5	.086	0	36°	PMT08432-SS	5	

*Complete nozzle part no. includes body and spray tip.

Maximum Operating Temperature: 160°F (70°C)
Maximum Pressure: 1500 PSI (100 bar)

DIMENSIONS IN INCHES (except as noted)

Nominal Size: 1/16 NPT/BSPT									
Nozzle & Port Detail	Mtl.	Part No. Complete Nozzle*	Pkg. Qty.	Orifice Dia. "d"	Extension "L"	"F" max (degrees)	Part No. Spray Tip Only	Pkg. Qty.	Spray Tip and Mating Port Detail
<p>1/16 NPT/BSPT 1/16 NPT or 1/16 BSPT</p>	BRASS	PM11610	5	.040	.25	34°	PMT08410	5	
		PM11615	5	.062	0	40°	PMT08415	5	
		PM11620	5	.062	.25	34°	PMT08420	5	
		PM11630	5	.086	0	36°	PMT08430	5	
	STAINLESS	PM11612-SS	5	.040	.25	34°	PMT08412-SS	5	
		PM11616-SS	5	.062	0	40°	PMT08416-SS	5	
		PM11622-SS	5	.062	.25	34°	PMT08422-SS	5	
		PM11632-SS	5	.086	0	36°	PMT08432-SS	5	

*Complete nozzle part no. includes body and spray tip.

Maximum Operating Temperature: 160°F (70°C)
Maximum Pressure: 1500 PSI (100 bar)



Pressure Max™

DIMENSIONS IN INCHES (except as noted)

Nominal Size: 1/8 NPT/BSPT									
Nozzle & Port Detail	Mtl.	Part No. Complete Nozzle *	Pkg. Qty.	Orifice Dia. "d"	Extension "L"	"F" max (degrees)	Part No. Spray Tip Only	Pkg. Qty.	Spray Tip and Mating Port Detail
<p>1/8 NPT/BSPT 1/8 NPT or 1/8 BSPT</p>	BRASS	PM04010	5	.040	.25	37°	PMT05020	5	<p>7/16"- 20 UNJF O-RING - 9mm ID x 1mm Ø Part No. OR10220</p>
		PM05010	5	.062	.25	37°	PMT04510	5	
		PM04022	5	.062	1.25	26°	PMT04514	5	
		PM06010	5	.086	.25	37°	PMT04520	5	
		PM04032	5	.086	1.25	26°	PMT04523	5	
		PM07001	5	.117	0	41°	PMT04525	5	
		PM04038	5	.117	.25	30°	PMT04526	5	
		PM04042	5	.117	1.25	26°	PMT04528	5	
		PM04046	5	.160	0	30°	PMT04534	5	
		PM04012-SS	5	.040	.25	37°	PMT04505-SS	5	
		PM04020-SS	5	.062	.25	37°	PMT04512-SS	5	
		PM04024-SS	5	.062	1.25	26°	PMT04516-SS	5	
		PM04030-SS	5	.086	.25	37°	PMT04522-SS	5	
		PM04034-SS	5	.086	1.25	26°	PMT04524-SS	5	
PM04039-SS	5	.117	0	41°	PMT04532-SS	5			
PM04040-SS	5	.117	.25	30°	PMT04527-SS	5			
PM04044-SS	5	.117	1.25	26°	PMT04529-SS	5			
PM04048-SS	5	.160	0	30°	PMT04536-SS	5			

*Complete nozzle part no. includes body and spray tip.

Maximum Operating Temperature: 160°F (70°C)
Maximum Pressure: 1500 PSI (100 bar)

DIMENSIONS IN INCHES (except as noted)

Nominal Size: 1/4 NPT/BSPT									
Nozzle & Port Detail	Mtl.	Part No. Complete Nozzle *	Pkg. Qty.	Orifice Dia. "d"	Extension "L"	"F" max (degrees)	Part No. Spray Tip Only	Pkg. Qty.	Spray Tip and Mating Port Detail
<p>1/4 NPT/BSPT 1/4 NPT or 1/4 BSPT</p>	BRASS	PM07100	5	.040	.25	36°	PMT07020	5	<p>1/2"- 20 UNJF O-RING - 11mm ID x 1mm Ø Part No. OR10230</p>
		PM07110	5	.062	.25	36°	PMT08010	5	
		PM04122	5	.062	1.25	32°	PMT08014	5	
		PM07120	5	.086	.25	36°	PMT08020	5	
		PM04132	5	.086	1.25	32°	PMT08024	5	
		PM07130	5	.117	0	44°	PMT08030	5	
		PM04139	5	.117	.25	36°	PMT08029	5	
		PM04158	5	.117	.50	36°	PMT08050	5	
		PM04142	5	.117	1.25	32°	PMT08034	5	
		PM07140	5	.160	0	36°	PMT08040	5	
		PM04148	5	.160	.50	32°	PMT08042	5	
		PM04152	5	.160	1.25	32°	PMT08044	5	
		PM04110-SS	5	.040	.25	36°	PMT08005-SS	5	
		PM04120-SS	5	.062	.25	36°	PMT08012-SS	5	
PM04124-SS	5	.062	1.25	32°	PMT08016-SS	5			
PM04130-SS	5	.086	.25	36°	PMT08022-SS	5			
PM04134-SS	5	.086	1.25	32°	PMT08026-SS	5			
PM04138-SS	5	.117	0	44°	PMT08028-SS	5			
PM04140-SS	5	.117	.25	36°	PMT08032-SS	5			
PM04159-SS	5	.117	.50	36°	PMT08051-SS	5			
PM04144-SS	5	.117	1.25	32°	PMT08036-SS	5			
PM04146-SS	5	.160	0	36°	PMT08041-SS	5			
PM04150-SS	5	.160	.50	32°	PMT08043-SS	5			
PM04154-SS	5	.160	1.25	32°	PMT08046-SS	5			

*Complete nozzle part no. includes body and spray tip.

Maximum Operating Temperature: 160°F (70°C)
Maximum Pressure: 1500 PSI (100 bar)



Pressure Max™

DIMENSIONS IN INCHES (except as noted)

Nominal Size: 3/8 NPT/BSPT										
Nozzle & Port Detail	Mtl.	Part No. Complete Nozzle*	Pkg. Qty.	Orifice Dia. "d"	Extension "L"	"F" max (degrees)	Part No. Spray Tip Only	Pkg. Qty.	Spray Tip and Mating Port Detail	
<p>3/8 NPT/BSPT 3/8 NPT or 3/8 BSPT</p>	BRASS	PM08210	5	.062	.38	40°	PMT08110	5	<p>5/8" - 18 UNJF O-RING - 13mm ID x 1mm Ø Part No. OR10240</p> <p>5/8" - 18 UNF x .30 DP MIN.</p>	
		PM08214	5	.062	1.25	40°	PMT08114	5		
		PM08220	5	.086	.38	40°	PMT08120	5		
		PM08224	5	.086	1.25	40°	PMT08124	5		
		PM08230	5	.117	.50	40°	PMT08130	5		
		PM08234	5	.117	1.25	40°	PMT08134	5		
		PM08238	5	.160	0	42°	PMT08138	5		
		PM08240	5	.160	.50	40°	PMT08140	5		
		PM08244	5	.160	1.25	40°	PMT08144	5		
		PM08258	5	.197	.50	34°	PMT08158	5		
		PM08248	5	.220	0	34°	PMT08148	5		
		PM08250	5	.220	.50	34°	PMT08150	5		
		PM08254	5	.220	1.25	34°	PMT08154	5		
		STAINLESS	PM08212-SS	5	.062	.38	40°	PMT08112-SS		5
			PM08216-SS	5	.062	1.25	40°	PMT08116-SS		5
	PM08222-SS		5	.086	.38	40°	PMT08122-SS	5		
	PM08226-SS		5	.086	1.25	40°	PMT08126-SS	5		
	PM08232-SS		5	.117	.50	40°	PMT08132-SS	5		
	PM08236-SS		5	.117	1.25	40°	PMT08136-SS	5		
	PM08239-SS		5	.160	0	42°	PMT08139-SS	5		
	PM08242-SS		5	.160	.50	40°	PMT08142-SS	5		
	PM08246-SS		5	.160	1.25	40°	PMT08146-SS	5		
	PM08260-SS		5	.197	.50	34°	PMT08160-SS	5		

*Complete nozzle part no. includes body and spray tip.

Maximum Operating Temperature: 160°F (70°C)

Maximum Pressure: 1500 PSI (100 bar)

DIMENSIONS IN INCHES (except as noted)

Nominal Size: M6, M8, M10											
Nozzle & Port Detail	Mtl.	Size "E"	Part No. Complete Nozzle*	Pkg. Qty.	Orifice Dia. "d"	Extension "L"	A	"F" max (degrees)	Part No. Spray Tip Only	Pkg. Qty.	Spray Tip and Mating Port Detail
<p>THREAD SIZE E</p>	STAINLESS	M6x1	PM22012-SS	5	.040	.25	.30	34°	PMT08412-SS	5	<p>5/16" - 24 UNJF O-RING - 6mm ID x 1mm Ø Part No. OR10210</p> <p>5/16" - 24 UNF x .30 DP MIN.</p>
			PM22016-SS	5	.062	0	.30	40°	PMT08416-SS	5	
			PM22022-SS	5	.062	.25	.30	34°	PMT08422-SS	5	
			PM22032-SS	5	.086	0	.30	36°	PMT08432-SS	5	
		M8x1.25	PM22112-SS	5	.040	.25	.33	34°	PMT08412-SS	5	
			PM22116-SS	5	.062	0	.33	40°	PMT08416-SS	5	
			PM22122-SS	5	.062	.25	.33	34°	PMT08422-SS	5	
			PM22132-SS	5	.086	0	.33	36°	PMT08432-SS	5	
			M10x1.25	PM22212-SS	5	.040	.25	.36	34°	PMT08412-SS	
		PM22216-SS		5	.062	0	.36	40°	PMT08416-SS	5	
		PM22222-SS		5	.062	.25	.36	34°	PMT08422-SS	5	
		PM22232-SS		5	.086	0	.36	36°	PMT08432-SS	5	
		M10x1.5	PM22312-SS	5	.040	.25	.36	34°	PMT08412-SS	5	
			PM22316-SS	5	.062	0	.36	40°	PMT08416-SS	5	
			PM22322-SS	5	.062	.25	.36	34°	PMT08422-SS	5	
PM22332-SS	5		.086	0	.36	36°	PMT08432-SS	5			

*Complete nozzle part no. includes body and spray tip.

Maximum Operating Temperature: 160°F (70°C)

Maximum Pressure: 1500 PSI (100 bar)



Compression Fittings

RECOMMENDED FOR USE WITH *JetTubes*[™] (see page 18)

■ Available in NPT and BSPT pipe threads

DIMENSIONS IN INCHES (except as noted)

MALE CONNECTOR (includes nut and sleeve)							
Part No.	Tube Size	Thread "E"	Straight Thread (Nut End)	"C" Hex	L	Pkg Qty	Configuration
CF15510	3/16	1/16 NPT/BSPT	3/8 - 24 UN	7/16	1.08	5	
CF15010		1/8 NPT		7/16	1.08	5	
CF15210		1/8 BSPT		7/16	1.08	5	
CF15030		1/4 NPT		9/16	1.27	5	
CF15230		1/4 BSPT		9/16	1.27	5	
CF15530		M8x1.0		7/16	1.10	5	
CF15535		M8x1.25		7/16	1.10	5	
CF15538		M10x1.0		7/16	1.13	5	
CF15540		M10x1.25		7/16	1.13	5	
CF15545		M10x1.5		7/16	1.13	5	
CF15020	1/4	1/8 NPT	7/16 - 24 UN	7/16	1.10	5	
CF15220		1/8 BSPT		7/16	1.10	5	
CF15040		1/4 NPT		9/16	1.30	5	
CF15240		1/4 BSPT		9/16	1.30	5	
CF15550		M12x1.75		1/2	1.20	5	
CF15025	5/16	1/8 NPT	1/2 - 24 UN	1/2	1.15	5	
CF15225		1/8 BSPT		1/2	1.15	5	
CF15050		1/4 NPT		9/16	1.33	5	
CF15250		1/4 BSPT		9/16	1.33	5	
CF15060	3/8	1/4 NPT	9/16 - 24 UN	9/16	1.42	5	
CF15260		1/4 BSPT		9/16	1.42	5	
CF15070		3/8 NPT		11/16	1.44	5	
CF15270		3/8 BSPT		11/16	1.44	5	

MALE ELBOW (includes nut and sleeve)							
Part No.	Tube Size	Thread "E"	Straight Thread (Nut End)	L	N	Pkg Qty	Configuration
CF15110	3/16	1/8 NPT	3/8 - 24 UN	.84	.69	5	
CF15310		1/8 BSPT		.84	.69	5	
CF15130		1/4 NPT		.86	.93	5	
CF15330		1/4 BSPT		.86	.93	5	
CF15120	1/4	1/8 NPT	7/16 - 24 UN	.86	.74	5	
CF15320		1/8 BSPT		.86	.74	5	
CF15140		1/4 NPT		.86	.94	5	
CF15340		1/4 BSPT		.86	.94	5	
CF15125	5/16	1/8 NPT	1/2 - 24 UN	.88	.74	5	
CF15325		1/8 BSPT		.88	.74	5	
CF15150		1/4 NPT		.95	.93	5	
CF15350		1/4 BSPT		.95	.93	5	
CF15160	3/8	1/4 NPT	9/16 - 24 UN	1.03	.93	5	
CF15360		1/4 BSPT		1.03	.93	5	
CF15170		3/8 NPT		1.03	1.00	5	
CF15370		3/8 BSPT		1.03	1.00	5	

NUT					
Part No.	Tube Size	Internal Thread	"C" Hex	Pkg Qty	Configuration
CF15410	3/16	3/8 - 24 UN	7/16	25	
CF15420	1/4	7/16 - 24 UN	1/2	25	
CF15422	5/16	1/2 - 24 UN	9/16	25	
CF15424	3/8	9/16 - 24 UN	5/8	25	

SLEEVE			
Part No.	Tube Size	Pkg Qty	Configuration
CF15430	3/16	25	
CF15440	1/4	25	
CF15450	5/16	25	
CF15460	3/8	25	

Material: Brass Maximum Pressure: 500 PSI (33 bar) Maximum Operating Temperature: 300°F (150°C)

Ordering Information

Determine if your machine employs NPT or BSPT ports. Order connectors and elbows to suit. Order spare nuts and sleeves to enable easy swapping of *JetTubes* without changing connectors.



Available in Brass or Acetal

FITS NPT and BSPT

DualFit™

STOP!
Now you can use NPT fittings on your metric machine tools! Put that NPT tap away!

These work great with TurretJets (pg 4) and CapJets! (pg 5)



PIPE FITTINGS FOR COOLANT NOZZLES

- Fits both NPT and BSPT (metric pipe) threads
- Compact design is ideal for tight spaces
- Allows you to use inch or metric fittings and nozzles
- Acetal version rated to 150 psi (10 bar) maximum
- Brass version rated to 1500 psi (100 bar) maximum



DualFit brass adaptor allows PressureMax nozzle to be used in screw-lock socket having BSPT port.

DIMENSIONS IN INCHES

	Part No.	Thread "E"	Thread "F"	Material	L	A	D	Dia "d"	Pkg Qty	Configuration
Close Nipple	DF08505	1/8 NPT/BSPT	1/8 NPT/BSPT	Acetal	.80	.40	.41	.25	5	
	DF08705B	1/8 NPT/BSPT	1/8 NPT/BSPT	Brass	.80	.40	.41	.25	5	
	DF08510	1/4 NPT/BSPT	1/4 NPT/BSPT	Acetal	.88	.44	.53	.31	5	
	DF08710B	1/4 NPT/BSPT	1/4 NPT/BSPT	Brass	.88	.44	.53	.31	5	
	DF08515	3/8 NPT/BSPT	3/8 NPT/BSPT	Acetal	1.00	.50	.66	.44	5	
	DF08715B	3/8 NPT/BSPT	3/8 NPT/BSPT	Brass	1.00	.50	.66	.44	5	
Long Nipple	DF08520	1/8 NPT/BSPT	1/8 NPT/BSPT	Acetal	1.50	.34	.41	.25	5	
	DF08720B	1/8 NPT/BSPT	1/8 NPT/BSPT	Brass	1.50	.34	.41	.25	5	
	DF08525	1/4 NPT/BSPT	1/4 NPT/BSPT	Acetal	1.50	.44	.53	.31	5	
	DF08725B	1/4 NPT/BSPT	1/4 NPT/BSPT	Brass	1.50	.44	.53	.31	5	
	DF08530	3/8 NPT/BSPT	3/8 NPT/BSPT	Acetal	1.50	.50	.66	.44	5	
	DF08730B	3/8 NPT/BSPT	3/8 NPT/BSPT	Brass	1.50	.50	.66	.44	5	
Bushing	DF08835B	M12x1.75	1/8 NPT/BSPT	Brass	.81	.50	.56	.28	5	
	DF08840B	M14x1.0	1/8 NPT/BSPT	Brass	.40	.28	.62	.31	5	
	DF08535	1/4 NPT/BSPT	1/8 NPT/BSPT	Acetal	.65	.44	.56	.31	5	
	DF08735B	1/4 NPT/BSPT	1/8 NPT/BSPT	Brass	.65	.44	.56	.31	5	
	DF08540	3/8 NPT/BSPT	1/4 NPT/BSPT	Acetal	.73	.50	.75	.42	5	
	DF08740B	3/8 NPT/BSPT	1/4 NPT/BSPT	Brass	.73	.50	.75	.42	5	
Adaptor	DF08545	1/8 NPT/BSPT	1/8 NPT/BSPT	Acetal	.78	.40	.46	.25	5	
	DF08745B	1/8 NPT/BSPT	1/8 NPT/BSPT	Brass	.78	.40	.46	.25	5	
	DF08550	1/4 NPT/BSPT	1/4 NPT/BSPT	Acetal	.93	.50	.60	.31	5	
	DF08750B	1/4 NPT/BSPT	1/4 NPT/BSPT	Brass	.93	.50	.60	.31	5	
	DF08555	3/8 NPT/BSPT	3/8 NPT/BSPT	Acetal	1.04	.55	.73	.37	5	
	DF08755B	3/8 NPT/BSPT	3/8 NPT/BSPT	Brass	1.04	.55	.73	.37	5	

Maximum Pressure: Acetal: 150 PSI (10 bar) Brass: 1500 PSI (100 bar)
Maximum Operating Temperature: Acetal: 160°F (70°C) Brass: 300°F (150°C)

WE RESERVE THE RIGHT TO CHANGE SPECIFICATIONS WITHOUT NOTICE OR OBLIGATION.

Adaptors are great for mounting TurretJet and PressureMax nozzles in counterbored ports

DF08840B is perfect for JOHN FORD Turning Centers



SprayTips



SCREW-IN, BRASS SPRAY TIPS FOR USE IN TAPPED-BALL NOZZLES

- Available in various orifice diameters ■ Ideal for concentrating the coolant stream at the cutting edge
- Angled outlet **SprayTips** enable aiming outside a nozzle's normal range of motion

DIMENSIONS IN INCHES (except as noted)

Type	Part No.	Thread "E"	Orifice Dia. "d"	L	A	"C" Hex	Pkg Qty	Configuration
Straight Outlet	ST16510	M3.5 x .6	.062	.42	.14	3/16	5	
	ST16515	M3.5 x .6	.086	.42	.14	3/16	5	
	ST16520	M4 x .7	.062	.54	.18	3/16	5	
	ST16525	M4 x .7	.086	.54	.18	3/16	5	
	ST16530	M5 x .8	.062	.63	.21	1/4	5	
	ST16535	M5 x .8	.086	.63	.21	1/4	5	
	ST16540	M5 x .8	.117	.63	.21	1/4	5	
	ST16545	M6 x 1.0	.062	.63	.21	1/4	5	
	ST16550	M6 x 1.0	.086	.63	.21	1/4	5	
	ST16555	M6 x 1.0	.117	.63	.21	1/4	5	
	ST16560	M6 x 1.0	.150	.63	.21	1/4	5	
	ST16565	M8 x 1.25	.062	.80	.30	3/8	5	
	ST16570	M8 x 1.25	.086	.80	.30	3/8	5	
	ST16575	M8 x 1.25	.117	.80	.30	3/8	5	
	ST16580	M8 x 1.25	.160	.80	.30	3/8	5	
	ST16585	M8 x 1.25	.220	.80	.30	3/8	5	
	ST16610	1/8NPT/BSPT	.062	.90	.37	1/2	5	
	ST16615	1/8NPT/BSPT	.086	.90	.37	1/2	5	
	ST16620	1/8NPT/BSPT	.117	.90	.37	1/2	5	
	ST16625	1/8NPT/BSPT	.160	.90	.37	1/2	5	
ST16630	1/8NPT/BSPT	.220	.90	.37	1/2	5		
ST16635	1/8NPT/BSPT	.280	.90	.37	1/2	5		
Angled Outlet	ST16650	M3.5 x .6	.062	.32	.14	3/16	5	
	ST16655	M4 x .7	.062	.36	.18	3/16	5	
	ST16660	M5 x .8	.086	.42	.21	1/4	5	
	ST16665	M6 x 1.0	.086	.42	.21	1/4	5	
	ST16670	M6 x 1.0	.117	.42	.21	1/4	5	



SprayTips can be used in a wide variety of nozzles including; **ScrewBalls, JetBolts, BrassBalls, BlackEyes, TurretJets, JetTubes, SweatJets, CapJets and BugEyes.**

Material: Brass

Maximum Pressure: 500 psi (33 bar)

Maximum Operating Temperature: 300°F (150°C)



Extension Tubes

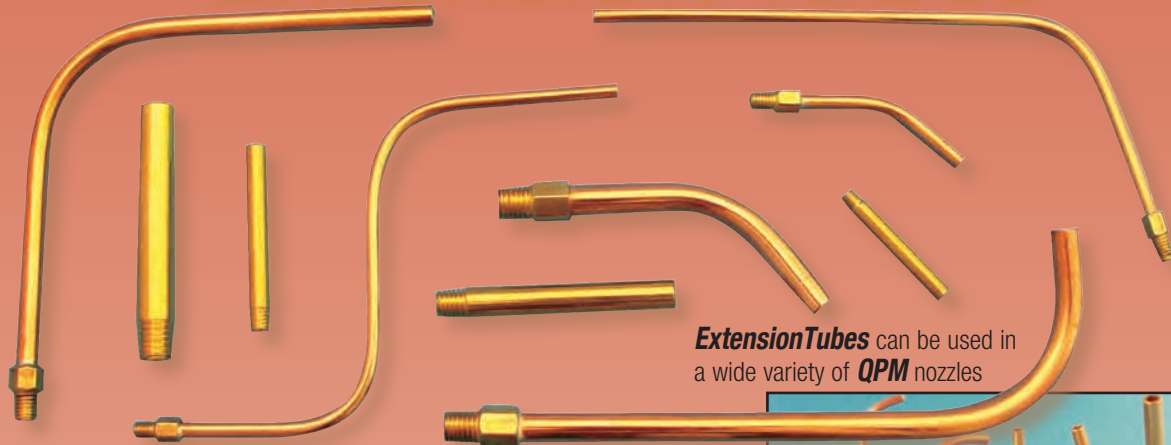

Extension Tubes can be used in a wide variety of **QPM** nozzles

- **Extension Tubes** install in seconds and make aiming a breeze
- Choose rigid brass **Extension Tubes** to direct coolant straight to the cutting edge
- Choose bendable copper **Extension Tubes** to direct coolant around obstructions
- Cut tube to desired length to suit your application



DIMENSIONS IN MILLIMETERS RIGID BRASS EXTENSION TUBES

PART NO. "E"	THREAD "L"	LENGTH "d"	INSIDE Qty	Pkg	Configuration
SBT09705	M3.5 X .6	30mm	2mm	5	
SBT09710	M4 x .7	30mm	2mm	5	
SBT09720	M5 x .8	40mm	3mm	5	
SBT09730	M6 x 1.0	50mm	4mm	5	
SBT09735	M7 x 1.0	55mm	5mm	5	
SBT09740	M8 x 1.25	55mm	5.5mm	5	

Material: Brass Maximum Pressure: 500 PSI (33 bar) Max Operating Temperature: 300°F (150°C)

DIMENSIONS IN INCHES (except as noted) BENDABLE COPPER EXTENSION TUBES

PART NO.	THREAD "E"	"C" Hex	Tubing Size "A"	Tubing ID "d"	Pkg Qty	Configuration
ET09805	M3.5 x .6	3/16"	1/8"	.07"	5	<p>Ideal for Coromant Capto* toolholders</p> <p><small>*Coromant Capto is a registered trademark of Sandvik AB</small></p>
ET09810	M4 x .7	3/16"	1/8"	.07"	5	
ET09820	M5 x .8	1/4"	3/16"	.12"	5	
ET09830	M6 x 1.0	1/4"	3/16"	.12"	5	
ET09835	M7 x 1.0	5/16"	1/4"	.18"	5	
ET09840	M8 x 1.25	5/16"	1/4"	.18"	5	
ET09845	M8 x .5	6mm	3/16"	.12"	5	
ET09850	M8 x .5	7mm	1/4"	.18"	5	
ET09855	M10 x .5	6mm	3/16"	.12"	5	
ET09860	M10 x .5	8mm	1/4"	.18"	5	
ET09865	M12 x .5	6mm	3/16"	.12"	5	
ET09870	M12 x .5	8mm	1/4"	.18"	5	
ET09875	M12 x .5	10mm	5/16"	.25"	5	



Brass Extension Tubes

are ideal for directing coolant straight to the cutting edges.

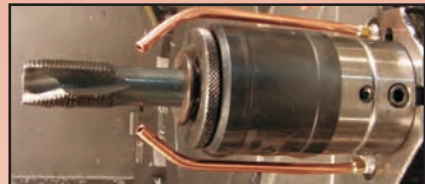

Bendable Extension Tubes allow coolant to be directed around obstructions such as floating tap holders (above) or insert clamps (below)

Material:
Hex Fitting: Brass
Tube: Copper
Solder: Lead-free

Max Pressure:
500 PSI (33 bar)

Maximum Operating Temperature: 300°F (150°C)

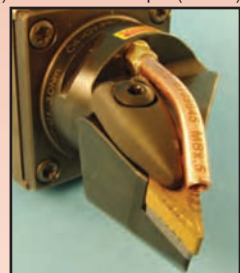

WE RESERVE THE RIGHT TO CHANGE SPECIFICATIONS WITHOUT NOTICE OR OBLIGATION.



JetTube™

Now available
in 4 tubing sizes

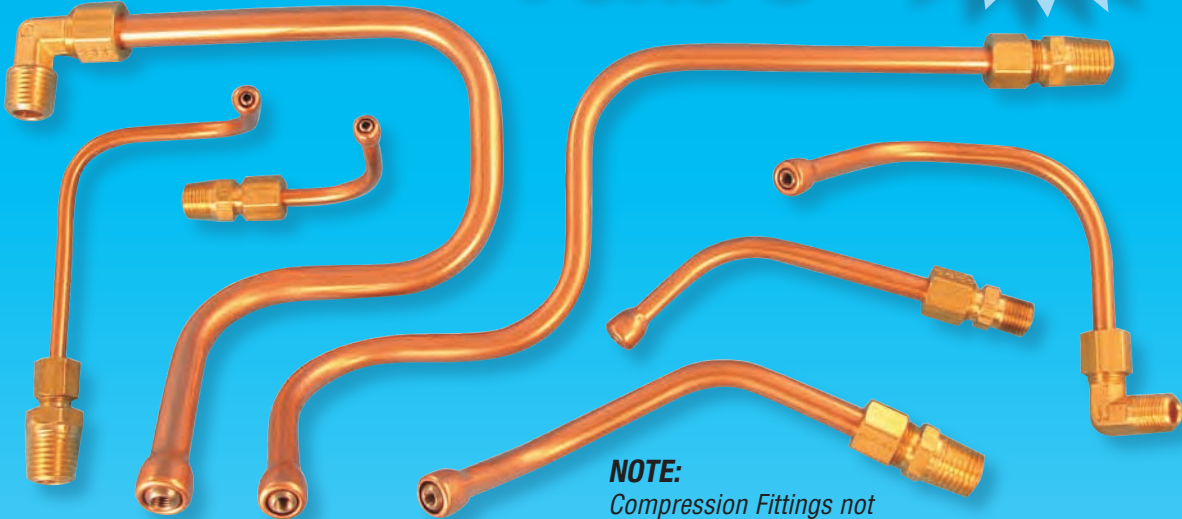

NOTE:
Compression Fittings not
included (see page 14)

COPPER TUBE WITH INTEGRAL, AIMABLE OUTLET ORIFICE

- Just cut the copper tube to your desired length, bend as required, then aim the spherical outlet orifice to hit your target
- Ideal for CNC grinders, mill/turn centers and screw machines
- Rated up to 500 psi (33 bar) (will vary with application)
- Metric tapped balls in the 1/4", 5/16", and 3/8" sizes allow use with **Extension Tubes** (page 17) and **Spray Tips** (page 16)

DIMENSIONS IN INCHES (except as noted)

PART NO.	TUBING SIZE "A"	LENGTH "L"	ORIFICE Dia. "d"	Pkg Qty
JT13010	3/16"	5 3/4"	.08"	5
JT13020	1/4"	5 3/4"	M3.5 x .6	5
JT13025	5/16"	11 3/4"	M4 x .7	5
JT13030	3/8"	11 3/4"	M5 x .8	5

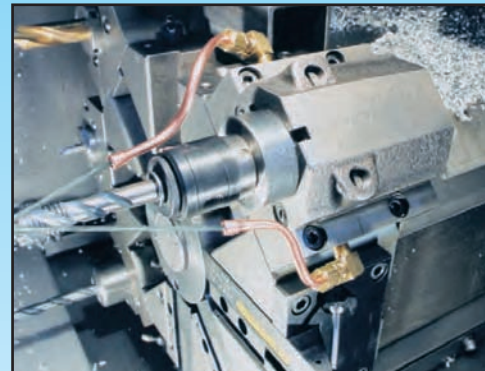
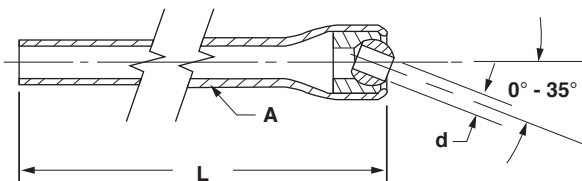

JetTubes shown on CNC turning center.

Material: Tube: Copper

Socket: Acetal

Ball: Stainless Steel

Maximum Pressure: 500 PSI (33 bar)

Maximum Operating Temperature: 160°F (70°C)



SweatJet™



SWEAT FITTINGS THAT ADAPT YOUR FAVORITE HOSES AND NOZZLES TO COPPER TUBING

- Easy to solder ■ Increases nozzle reliability by allowing use of short rigid hoses ■ Rated to 500 psi†
- Allows **SwivelMax**, 1/4" Loc-Line*, **QPM Spray Tips** and **PressureMax Spray Tips** to be used on copper tubing
- Ideal for CNC Tool and Cutter Grinders, CNC Mill/Turn Centers and screw machines

DIMENSIONS IN INCHES (except as noted)

BALL TYPE (fits <i>SwivelMax</i> or 1/4" Loc-Line*)								
Part No.	Tubing Size "A"	Outlet Ball Fits:	L	F	Dia "D"	Dia "d"	Pkg Qty	Configuration
SJ14040	1/4	SwivelMax	.99	.38	.38	.22	5	
SJ14045	1/4	1/4" Loc-Line	.52	.38	.38	.22	5	
SJ14050	5/16	SwivelMax	1.05	.44	.44	.22	5	
SJ14055	5/16	1/4" Loc-Line	.90	.44	.44	.28	5	
SJ14060	3/8	SwivelMax	1.15	.50	.49	.22	5	
SJ14065	3/8	1/4" Loc-Line	1.08	.56	.50	.28	5	



THREADED TYPE (fits <i>QPM SprayTips</i> - see page 16)								
Part No.	Tubing Size "A"	Outlet Thread "E"	L	F	B	"C" Hex	Pkg Qty	Configuration
SJ14130	3/16	M5 x .8	.56	.31	.25	.25	5	
SJ14140	1/4	M6 x 1.0	.62	.37	.25	.31	5	
SJ14150	5/16	M8 x 1.25	.81	.50	.31	.38	5	
SJ14160	3/8	1/8 NPT/BSPT	.94	.56	.25	.50	5	

SweatJets allow a wide variety of nozzles to be mounted to copper tubing.

PressureMax TYPE (fits <i>PressureMax SprayTips</i> - see pages 10-13)								
Part No.	Tubing Size "A"	Outlet Thread "E"	L	F	B	"C" Hex	Pkg Qty	Configuration
SJ14240	1/4	5/16-24 UNJF	.68	.38	.20	.44	5	
SJ14245	1/4	7/16-20 UNJF	.75	.42	.20	.56	5	
SJ14250	5/16	7/16-20 UNJF	.75	.44	.20	.56	5	
SJ14255	5/16	1/2-20 UNJF	1.0	.56	.25	.62	5	
SJ14260	3/8	7/16-20 UNJF	.75	.44	.20	.56	5	
SJ14265	3/8	1/2-20 UNJF	1.0	.56	.25	.62	5	



SweatJets are easy to solder using a propane torch.

Material: Brass
 Maximum Pressure: 500 psi (33 bar)
 Maximum Operating Temperature: 160° F (70° C)

Refrigeration Grade Coil
 Length = 118 in (3 m)

SOLDER
 Highly recommended for soldering *SweatJets*
 Part No. SOL14600
 .062" (1.5 mm)
 Lead Free, Rosin Core
 4 oz. (227g) roll



† DO NOT EXCEED MAXIMUM PRESSURE RATING OF MATING HOSE SYSTEM

* LOC-LINE IS A TRADEMARK OF LOCKWOOD PRODUCTS INC.

WE RESERVE THE RIGHT TO CHANGE SPECIFICATIONS WITHOUT NOTICE OR OBLIGATION.

COPPER TUBING

Part No.	Tubing Size	TUBE I.D.
COP14730	3/16	.12
COP14740	1/4	.18
COP14750	5/16	.25
COP14760	3/8	.31





Available with **FixedFlow** or **VariFlow** end nozzles

New Adaptors!
Now you can attach Loc-Line* and Snap-Loc** nozzles to **SwivelMax** hose!

SwivelMax™

RATED TO 100 PSI (6.7 BAR)

Each joint swivels an incredible 72° either side of centerline



MODULAR COOLANT NOZZLE SYSTEM FOR CNC AND MANUAL MACHINE TOOLS

- Extremely versatile system with incredible range of motion in each joint
- Compact design is ideal for tight spaces
- Available with **FixedFlow** or **VariFlow** nozzles and interchangeable orifices
- Rated to 100 PSI* (6.7 bar) maximum
- Available with threaded or spherical bases
- Vibration resistant joints provide superior reliability in CNC lathe turrets where inertial forces are high
- New adaptors allow attachment to Loc-Line* and Snap-Loc** systems



SwivelMax system with **FixedFlow** end nozzles is ideal for CNC lathes due to its compactness and flexibility.



VariFlow end nozzles enable infinite flow control from full shutoff to full flow with fingertip control. They are ideal for manual and CNC mills.

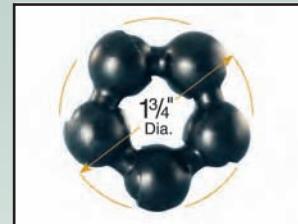

SwivelMax links swivel 72° either side of centerline enabling it to come full circle within a 1 3/4" inscribed circle.

ORDERING INFORMATION

SwivelMax components can be ordered in packages using the Part No.'s below (pliers SM02910 are required for assembly and disassembly). They can also be ordered pre-assembled in a wide variety of configurations. To order pre-assembled nozzles, specify the type of base, the number of intermediate links, end nozzle and orifice diameter as per examples below.

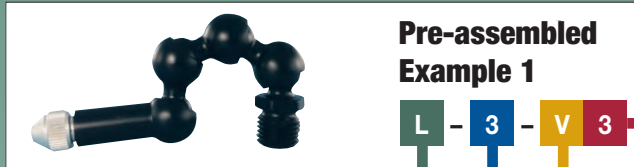

Pre-assembled Example 1

L - 3 - V 3

VariFlow Spray Tips (for Type V Nozzles only)					
Type	Part No.	Orifice Dia. d	Color	Pkg. Qty.	Configuration
1	SM02820	.086"	Blue	5	 Material: Aluminum
2	SM02830	.117"	Gold	5	
3	SM02840	.160"	Silver	5	
—	SM02850	Variety Pack contains one each of above			

Base				
Type	Size "E"	Part No.	Pkg. Qty.	Configuration
G	10mm BALL	SM02505	5	 Material: Brass
A	12mm BALL	SM02510	5	
B	14mm BALL	SM02515	5	
C	15mm BALL	SM02520	5	
D	22mm BALL	SM02525	5	
E	1/2" BALL	SM02530	5	
F	5/8" BALL	SM02535	5	
K	1/8 NPT/BSPT	SM02540	5	 Material: Acetal
L	1/4 NPT/BSPT	SM02545	5	
M	M10 x 1.25	SM02550	5	
N	M10 x 1.5	SM02555	5	
P	M12 x 1.25	SM02560	5	
Q	M12 x 1.75	SM02565	5	
R	M14 x 1.0	SM02570	5	
S	M14 x 2.0	SM02575	5	

Intermediate Links

Part No.	Pkg. Qty.	Configuration
SM02610	5	 Material: Acetal
For Pre-assembled nozzles Specify Quantity from 0-9		

Maximum Pressure: 100 PSI (6.7 bar) max.†
 Maximum Temperature: 110°F (43°C)
 Inside Diameter: .20 inches

VariFlow End Nozzle			
Type	Part No.	Pkg. Qty.	Configuration
V	SM02810	5	 Material: Acetal

FixedFlow End Nozzle			
Type	Part No.	Pkg. Qty.	Configuration
F	SM02710	5	 Material: Acetal

DIMENSIONS IN INCHES (except as noted)

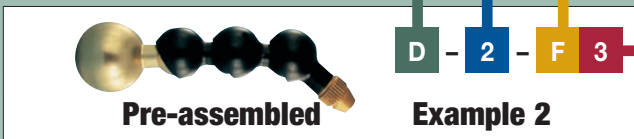

D - 2 - F 3

FixedFlow Spray Tips (for Type F Nozzles only)					
Type	Part No.	Orifice Dia. d	Color	Pkg. Qty.	Configuration
1	SM02720	.062"	Red	5	 Material: Aluminum
2	SM02730	.086"	Blue	5	
3	SM02740	.117"	Gold	5	
4	SM02750	.160"	Silver	5	
—	SM02760	Variety Pack contains one each of above			

Adaptors (not available pre-assembled)

SwivelMax to 1/4" LocLine*			SwivelMax to 1/4" SnapLoc**			1/4" SnapLoc** to SwivelMax			1/4" LocLine* to SwivelMax			Reversing Link		
Part No.	Pkg. Qty.	Configuration	Part No.	Pkg. Qty.	Configuration	Part No.	Pkg. Qty.	Configuration	Part No.	Pkg. Qty.	Configuration	Part No.	Pkg. Qty.	Configuration
SM02640	5	 Material: Acetal	SM02660	5	 Material: Acetal	SM02650	5	 Material: Acetal	SM02630	5	 Material: Acetal	SM02620	5	 Material: Acetal



Assembly Pliers
 These are a must to assemble or disassemble **SwivelMax** parts. High quality construction with lifetime warranty.



Adaptors

Use adaptors to attach LocLine* and SnapLoc** nozzles to **SwivelMax** hose and vice versa. Application examples shown above are (left to right)
 SM02640 - used to attach LocLine* spray-bar to **SwivelMax** hose
 SM02660 - used to attach SnapLoc** flare nozzle to **SwivelMax** hose
 SM02650 - used to attach **Fixed-Flow** nozzle to SnapLoc** hose
 SM02630 - used to attach **Vari-Flow** nozzle to LocLine* hose

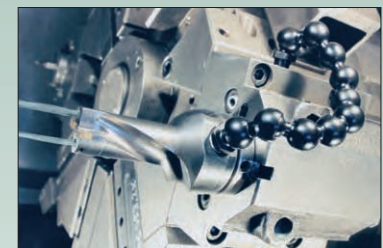

Reversing Link

Allows bases to be used on both ends of assembled **SwivelMax** line; ideal for plumbing coolant to insert drills (not available pre-assembled).

*LOC LINE IS A TRADEMARK OF LOCKWOOD PRODUCTS INC. **SNAP LOC IS A TRADEMARK OF CEDARBURG INDUSTRIES

† DO NOT EXCEED MAXIMUM PRESSURE RATING OF MATING HOSE SYSTEM
 WE RESERVE THE RIGHT TO CHANGE SPECIFICATIONS WITHOUT NOTICE OR OBLIGATION.

**FITS
NPT & BSPT
THREADS**



MODULAR HOSE SYSTEM



TO GET WHERE OTHERS CANNOT REACH

- *Extremely flexible system affords unparalleled range of motion*
- *Vibration resistant* ■ *Non electro-conductive* ■ *Resistant to chemical agents*
- *Fits NPT and BSPT threads*



Material: Acetal
Maximum Operating Temperature: 122°F (50° C)
Maximum Pressure: up to 90 PSI (6 bar)
(will vary with application)

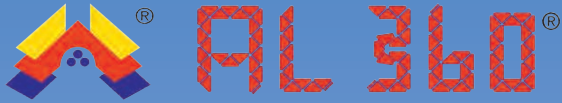

AL 360 - Standard Fittings			Inside Diameter 10mm (3/8 inch)		
	Part No.	Description		Part No.	Description
	AL1818	Standard Pack 22 radial connectors 3 nozzles (2mm, 3.5mm & 6.5mm dia. orifice) 2 fittings (1/4" and 1/8" NPT/BSPT) Overall length = 335mm		AL1833	Pack of 4 connectors (45°)
				AL1835	Pack of 2 tees
	AL1819	22 radial connectors (length = 305mm)		AL1837	Pack of 4 nozzles (10mm diameter)
	AL1821	Pack of 4 nozzles (2mm diameter)		AL1839	Pack of 4 fittings (3/8" NPT/BSPT)
	AL1823	Pack of 4 nozzles (3.5mm diameter)		AL1841	Pack of 2 flat nozzles (55mm x 3.5mm)
	AL1825	Pack of 4 nozzles (6.5mm diameter)		AL1843	Pack of 4 fittings (1/8" NPT/BSPT)
	AL1827	Pack of 2 flat nozzles (26.5mm x 1mm)		AL1845	Pack of 4 fittings (1/4" NPT/BSPT)
	AL1829	Pack of 4 fittings (1/8" NPT/BSPT)		AL1847	Pack of 4 nozzles (2mm diameter - 9 holes)
	AL1831	Pack of 4 fittings (1/4" NPT/BSPT)			

Assembly Pliers

Versatile pliers ease assembly of AL360 connectors

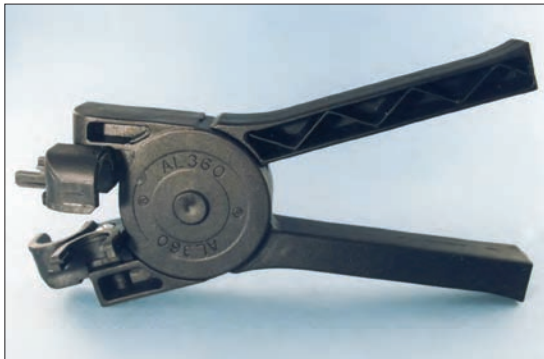

Part No. AL6295

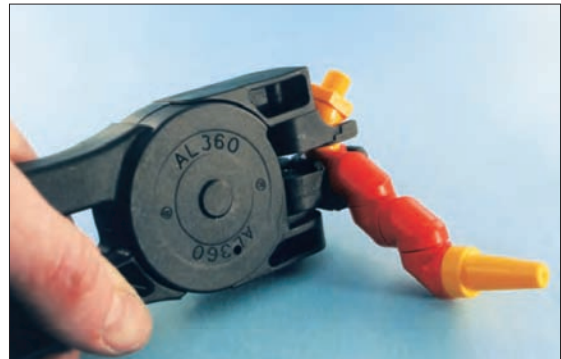



Brass Balls™



SCREW-LOCK BRASS BALL COOLANT NOZZLES FOR CNC LATHES

- Conventional brass ball nozzles available in a variety of orifice sizes and configurations
- Tapped balls can be plugged with setscrew (included), or used with **Extension Tubes** (See page 17)

DIMENSIONS IN INCHES (except as noted)

Type	Part No.	Nom. Dia "D"	Orifice Dia "d"	Extension "L"	Pkg Qty	Configuration
DRILLED HOLE	BB11004	10 mm	.11	0	5	
	BB11007	10 mm	.16	0	5	
	BB11014	11 mm	.11	0	5	
	BB11015	11 mm	.16	0	5	
	BB11024	12 mm	.16	0	5	
	BB11027	12 mm	.22	0	5	
	BB11037	14 mm	.16	0	5	
	BB11040	14 mm	.22	0	5	
	BB11049	15 mm	.16	0	5	
	BB11052	15 mm	.22	0	5	
	BB11057	18mm	.16	0	5	
	BB11058	18mm	.22	0	5	
	BB11071	22 mm	.16	0	5	
	BB11074	22 mm	.22	0	5	
	BB11083	1/2 inch	.16	0	5	
BB11086	1/2 inch	.22	0	5		
BB11107	5/8 inch	.16	0	5		
BB11110	5/8 inch	.22	0	5		
TAPPED HOLE	BB11001	10 mm	M6x1.0	0	5	
	BB11016	11 mm	M5x.8	.24	5	
	BB11018	12 mm	M5x.8	.24	5	
	BB11031	14 mm	M6x1.0	.31	5	
	BB11043	15 mm	M6x1.0	.31	5	
	BB11059	18mm	M6x1.0	.31	5	
	BB11065	22 mm	M6x1.0	.31	5	
	BB11077	1/2 inch	M5x.8	.24	5	
	BB11101	5/8 inch	M6x1.0	.31	5	
	ANGLED OUTLET HOLE	BB11012	10 mm	.11	.25	
BB11017		11 mm	.16	.36	5	
BB11021		12 mm	.16	.36	5	
BB11034		14 mm	.16	.36	5	
BB11046		15 mm	.16	.36	5	
BB11060		18 mm	.16	.36	5	
BB11068		22 mm	.16	.36	5	
BB11080		1/2 inch	.16	.36	5	
BB11104		5/8 inch	.16	.36	5	



The upper port on this boring bar holder uses an Angled Outlet BrassBall, while the lower port employs a Tapped Hole BrassBall fitted with a Bendable Extension Tube.

Material: Brass
 Maximum Pressure: 500 psi (33 bar)
 Maximum Operating Temperature: 300°F (150°C)

WE RESERVE THE RIGHT TO CHANGE SPECIFICATIONS WITHOUT NOTICE OR OBLIGATION.



New metric tapped balls allow use with Extension Tubes and Spray Tips.

BlackEye™



Available with tapped ball to allow quick plugging!

SCREW-LOCK COOLANT NOZZLE FOR CNC LATHES

- An easy-to-aim replacement for screw-lock spherical coolant nozzles.
- Rated to 150 psi (10 bar) maximum ■ Sizes available to fit almost every machine or toolholder.
- Just install and tighten lock-screw once, then aim the stainless steel ball with the tip of your allen wrench.
- Choose tapped ball if you need to quickly plug the orifice (set screw included) or to use with **Extension Tubes** (page 17) or **Spray Tips** (page 16)

BlackEye™ Nozzles replace these:

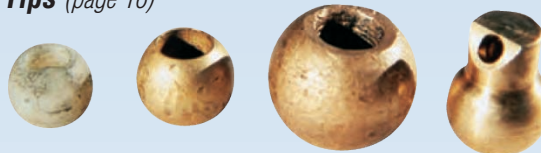

DIMENSIONS IN INCHES (except as noted)

Part No.	Nom. Dia. "D"	Orifice Dia. "d"	Pkg Qty
BE00112	10 mm	.11	5
BE00212	10 mm	M3.5 x .6	5
BE00107	12 mm	.16	5
BE00222	12 mm	M4 x .7	5
BE00108	14 mm	.16	5
BE00232	14 mm	M4 x .7	5
BE00109	15 mm	.16	5
BE00242	15 mm	M4 x .7	5
BE02020	18 mm	.16	5
BE02032	18 mm	M5 x .8	5
BE00110	22 mm	.22	5
BE00252	22 mm	M6 x 1.0	5
BE00120	3/8 inch	.11	5
BE00262	3/8 inch	M3.5 x .6	5
BE00111	1/2 inch	.16	5
BE00272	1/2 inch	M4 x .7	5
BE02010	5/8 inch	.16	5
BE00282	5/8 inch	M4 x .7	5



BlackEyes shown in boring bar holder.

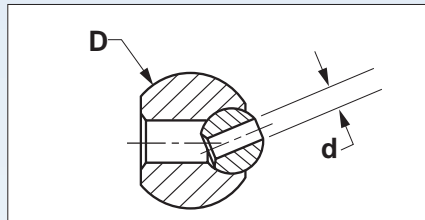

Material: Body - Acetal
Ball - Stainless Steel
Max Operating Temperature: 160°F (70°C)
Maximum Pressure: 150 PSI (10 bar)



BlackEye installed on quick change turning tool.

Ordering Information: Measure the diameter of the original ball in your machine and order the nominal diameter to suit.



New metric tapped balls allow use with Extension Tubes (page 17) and Spray Tips (page 16).

BUGEYE™



SCREW-LOCK BALL EXTENDED COOLANT NOZZLE FOR CNC LATHES

- Extended ball socket provides greater range of aimability than the **BlackEye** (page 25) while still being relatively compact
- Ideal for tool positions where tool tip is difficult to reach with standard screw-lock ball (i.e. short tool projections)
 - Rated to 150 PSI maximum
 - Sizes available to fit almost every machine or toolholder
 - Choose the orifice diameter to suit your application

DIMENSIONS IN INCHES (except as noted)

Part No.	Nominal Dia. "D"	Orifice Dia. "d"	L	Pkg Qty
BUG02305	12 mm	.11	1.10	5
BUG02310	12 mm	.16	1.10	5
BUG02312	12 mm	M6 x 1.0	1.10	5
BUG02315	14 mm	.11	1.20	5
BUG02320	14 mm	.16	1.20	5
BUG02322	14 mm	M6 x 1.0	1.20	5
BUG02325	15 mm	.11	1.23	5
BUG02330	15 mm	.16	1.23	5
BUG02332	15 mm	M6 x 1.0	1.23	5
BUG02335	22 mm	.11	1.50	5
BUG02340	22 mm	.16	1.50	5
BUG02342	22 mm	M6 x 1.0	1.50	5
BUG02345	1/2 inch	.11	1.12	5
BUG02350	1/2 inch	.16	1.12	5
BUG02352	1/2 inch	M6 x 1.0	1.12	5
BUG02355	5/8 inch	.11	1.23	5
BUG02360	5/8 inch	.16	1.23	5
BUG02362	5/8 inch	M6 x 1.0	1.23	5

Material:
 Body: Acetal
 Ball: Stainless Steel

Maximum Pressure:
 150 PSI (10 bar)

Maximum Operating Temperature: 160° F (70° C)

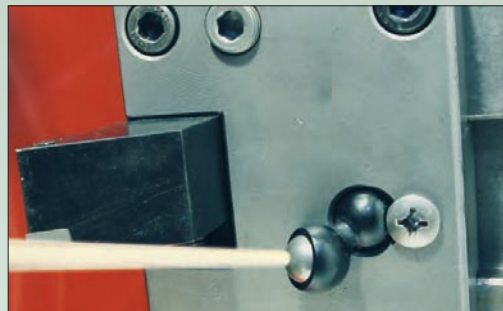
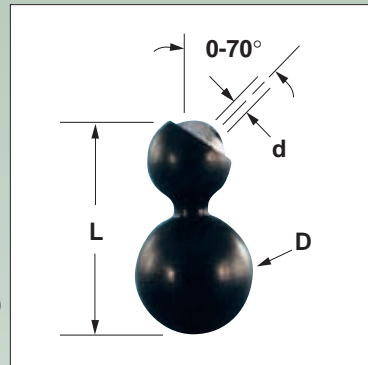

BugEye shown installed on CNC turning center.

Ordering Information: Measure the diameter of the original ball in your machine and order the nominal diameter to suit.



LolliPop™

SCREW-LOCK BALL COOLANT NOZZLE WITH INTEGRAL COPPER TUBE FOR CNC LATHES

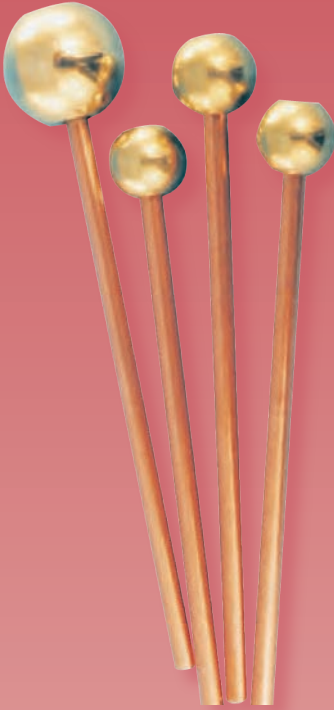

- Just cut the copper tube to your desired length and bend as required
- Space efficient design is ideal for tight spaces
- Ideal for machines with live tooling
- Unlimited routing possibilities
- Rated to 500 psi (33 bar)
- Sizes available to fit almost every machine or toolholder
- Choose 3/16" tubing for ease of bending or 1/4" tubing for maximum flow

DIMENSIONS IN INCHES (except as noted)

Part No.	Ball Dia. "D"	Tubing Size "A"	Tubing I.D. "d"	Pkg Qty
LP05500	8 mm	4 mm	2 mm	5
LP05501	9 mm	3/16"	.12	5
LP05502	10 mm	3/16"	.12	5
LP05504	11 mm	3/16"	.12	5
LP05506	12 mm	3/16"	.12	5
LP05508	12 mm	1/4"	.18	5
LP05510	14 mm	3/16"	.12	5
LP05512	14 mm	1/4"	.18	5
LP05514	15 mm	3/16"	.12	5
LP05516	15 mm	1/4"	.18	5
LP05518	18 mm	3/16"	.12	5
LP05520	18 mm	1/4"	.18	5
LP05522	22 mm	3/16"	.12	5
LP05524	22 mm	1/4"	.18	5
LP05526	3/8 inch	3/16"	.12	5
LP05530	1/2 inch	3/16"	.12	5
LP05532	1/2 inch	1/4"	.18	5
LP05534	5/8 inch	3/16"	.12	5
LP05536	5/8 inch	1/4"	.18	5

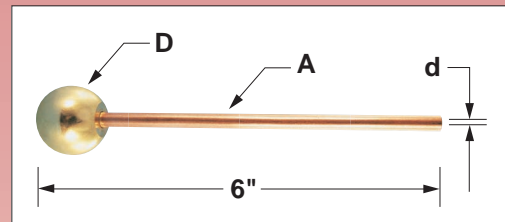

LolliPop nozzle shown installed in lathe turret.

Material: Ball - Brass • Tube - Copper • Solder - Lead Free
 Maximum Operating Temperature: 300°F (150°C)
 Maximum Pressure: 500 PSI (33 bar)

Ordering Information

Measure the diameter of the original ball in your machine and order the nominal diameter to suit (specify desired tubing size).



TwinPop™



SCREW-LOCK BALL COOLANT NOZZLE WITH TWO COPPER TUBES

- Double tubes allow coolant to be directed above AND below the tool, using only one port.

DIMENSIONS IN INCHES (except as noted)

Part No.	Ball Dia. "D"	Tubing Size "A"	Tubing I.D. "d"	Pkg Qty
TP05805	1/2 inch	3/16"	.12	5
TP05810	5/8 inch	3/16"	.12	5
TP05815	12mm	3/16"	.12	5
TP05820	14mm	3/16"	.12	5
TP05825	15mm	3/16"	.12	5
TP05827	18mm	3/16"	.12	5
TP05830	22mm	3/16"	.12	5

Material: Ball - Brass • Tube - Copper • Solder - Lead Free
 Maximum Operating Temperature: 300°F (150°C)
 Maximum Pressure: 500 psi (33 bar)

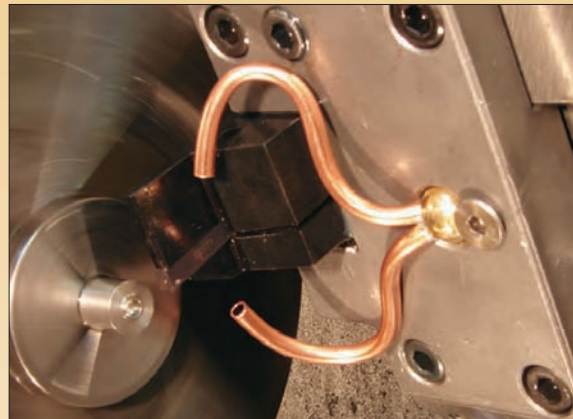

TwinPop nozzle shown installed in lathe turret.

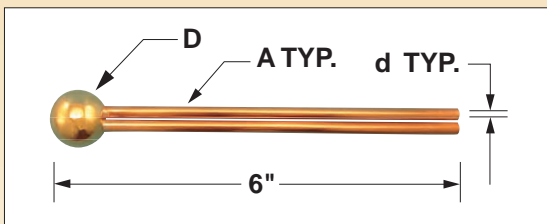

Ordering Information

Measure the diameter of the original ball in your machine and order the nominal diameter to suit.



Now available in Brass or Acetal

OddBall™



SCREW-LOCK BALLS THAT ADAPT YOUR FAVORITE HOSES AND NOZZLES TO FIT YOUR CNC LATHE

- Allows Loc-Line*, Snap-Loc** and 1/8 NPT/BSPT fittings to be used on CNC lathes that employ screw-lock balls.
- Sizes available to fit almost every machine or toolholder
- Choose acetal material for low pressures up to 150 psi (10 bar) †
- Choose brass material for higher pressures up to 500 psi (33 bar) †

DIMENSIONS IN INCHES (except as noted)

Mtl	Part No.	Nom. Dia. "D"	Adaptor Type	Through hole	Length "L"	Pkg. Qty.
ACETAL	OB06501	10 mm	1	.25 dia.	.63	5
	OB06502	12 mm	1	.25 dia.	.67	5
	OB06504	12 mm	2	.25 dia.	.76	5
	OB06506	12 mm	4	.25 dia.	.91	5
	OB06508	14 mm	1	.25 dia.	.76	5
	OB06510	14 mm	2	.25 dia.	.84	5
	OB06512	14 mm	3	.25 dia.	.38	5
	OB06514	15 mm	1	.25 dia.	.81	5
	OB06516	15 mm	2	.25 dia.	.89	5
	OB06518	15 mm	3	.25 dia.	.43	5
	OB06526	22 mm	1	.25 dia.	1.12	5
	OB06528	22 mm	2	.25 dia.	1.20	5
	OB06530	22 mm	3	.25 dia.	.74	5
	OB06532	1/2 inch	1	.25 dia.	.71	5
	OB06534	1/2 inch	2	.25 dia.	.79	5
OB06536	1/2 inch	4	.25 dia.	.94	5	
OB06538	5/8 inch	1	.25 dia.	.87	5	
OB06540	5/8 inch	2	.25 dia.	.95	5	
OB06542	5/8 inch	3	.25 dia.	.47	5	
BRASS	OB06601	10mm	1	.25 dia.	.64	5
	OB06602	12mm	1	.25 dia.	.67	5
	OB06606	12mm	4	7/32 hex	.90	5
	OB06608	14mm	1	.25 dia.	.77	5
	OB06612	14mm	3	7/32 hex	.39	5
	OB06614	15mm	1	.25 dia.	.81	5
	OB06618	15mm	3	7/32 hex	.45	5
	OB06626	22mm	1	.25 dia.	1.15	5
	OB06630	22mm	3	7/32 hex	.77	5
	OB06632	1/2 inch	1	.25 dia.	.71	5
	OB06636	1/2 inch	4	7/32 hex	.94	5
	OB06638	5/8 inch	1	.25 dia.	.87	5
	OB06642	5/8 inch	3	7/32 hex	.49	5

TYPE 1 - Fits 1/4" LOC-LINE*

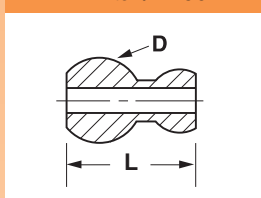

TYPE 2 - Fits 1/4" SNAP-LOC**

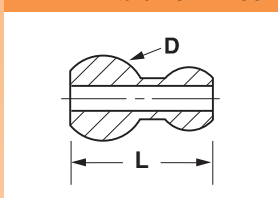

TYPE 3 - Fits 1/8 NPT/BSPT

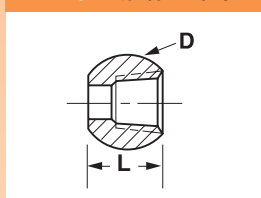

TYPE 4 - Fits 1/8 NPT/BSPT

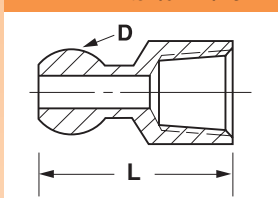

Maximum Pressure: Acetal: 150 PSI (10 bar) †
Brass: 500 PSI (33 bar) †

Maximum Operating Temperature: Acetal: 160°F (70°C)
Brass: 300°F (150°C)



TYPE 1 **OddBall** attached to 1/4" Loc-Line* hose.



TYPE 2 **OddBall** attached to 1/4" Snap-Loc** hose.

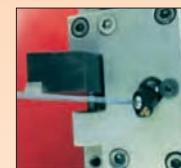

TYPE 3 **OddBall** threaded onto 1/8 NPT/BSPT TurretJet.

Ordering Information: Measure the diameter of the original ball in your machine and order the nominal diameter that suits your favorite nozzle system.

* LOC-LINE IS A TRADEMARK OF LOCKWOOD PRODUCTS INC. ** SNAP-LOC IS A TRADEMARK OF CEDARBURG INDUSTRIES

† DO NOT EXCEED MAXIMUM PRESSURE RATING OF MATING HOSE SYSTEM

WE RESERVE THE RIGHT TO CHANGE SPECIFICATIONS WITHOUT NOTICE OR OBLIGATION.



JiffyJet™



PRESS-IN COOLANT NOZZLE

- Just drill and ream a hole, press in a **JiffyJet**, and you've got an easily aimable coolant nozzle!
- Ideal for special tooling, VDI holders, CNC lathe tooling, screw machines, etc.
- Rated to 150 psi (10 bar) maximum ■ ±35° of adjustment either side of centerline



1 Drill coolant passage, leaving reaming allowance.



2 Ream hole to nominal size $-0 \pm .002$."



3 Press in **JiffyJet** until body is flush.

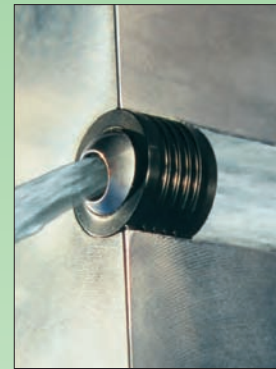

Cutaway view showing **JiffyJet** installed.

DIMENSIONS IN INCHES (except as noted)

Part No.	Nom. Dia. "D"	A	B	Orifice Dia. "d"	E(degrees)	Prepared Hole Dia.	Pkg Qty
JJ07050	1/4 inch	.190	.05	.08	35°	.250/.2515	5
JJ00103	5/16 inch	.250	.06	.11	35°	.3125/.3145	5
JJ00104	3/8 inch	.312	.08	.16	35°	.375/.377	5
JJ00105	7/16 inch	.360	.10	.16	35°	.4375/.4395	5
JJ00106	9/16 inch	.437	.13	.22	35°	.5625/.5645	5
JJ00118	5/8 inch	.437	.13	.22	35°	.625/.627	5
JJ07160	6 mm	.190	.05	.06	35°	.2362/.2377	5
JJ07150	6 mm	.190	.05	.08	35°	.2362/.2377	5
JJ00119	8 mm	.250	.06	.11	35°	.315/.317	5
JJ00113	10 mm	.312	.08	.16	35°	.3937/.3957	5
JJ00114	12 mm	.360	.10	.16	35°	.4724/.4744	5
JJ00115	14 mm	.437	.13	.22	35°	.551/.553	5
JJ00116	15 mm	.437	.13	.22	35°	.5906/.5926	5

– Please contact us for availability of other sizes or for special orders –

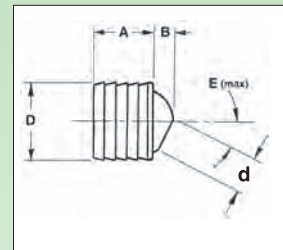

Material:
 Body - Acetal
 Ball - Stainless Steel

Max Operating Temperature: 160°F (70°C)

Maximum Pressure:
 150 PSI (10 bar)



ScrewBall™

CONTACT US FOR CUSTOM ORDERS

CONTACT US FOR BULK PRICING



NEW COLORS NOW AVAILABLE

PRESS-IN COOLANT NOZZLE WITH TAPPED HOLE

- Just drill and ream a hole, press in a **ScrewBall**, and you've got an easily aimable coolant nozzle
- Threaded hole can be fitted with an **ExtensionTube** (page 17), **SprayTip** (page 16), or plugged with a setscrew (not included) ■ ±35 degrees of adjustment either side of centerline
- Ideal for quick change toolholders with multiple ports ■ Rated to 150 PSI (10 bar) max
- Choose Black or White body color for best economy

DIMENSIONS IN MILLIMETERS

Part No.	Nominal Dia "D"	Body Color	"A"	Thread "B"	"C"	Prepared Hole Tolerance	Pkg Qty	Configuration
SB09505	8 mm	White	6	M3.5x.6	1.5	H9	5	
SB09506	8 mm	Black	6	M3.5x.6	1.5	H9	5	
SB09507	8 mm	Blue	6	M3.5x.6	1.5	H9	5	
SB09508	8 mm	Yellow	6	M3.5x.6	1.5	H9	5	
SB09509	8 mm	Orange	6	M3.5x.6	1.5	H9	5	
SB09510	10 mm	White	7	M4x.7	2.0	H9	5	
SB09511	10 mm	Black	7	M4x.7	2.0	H9	5	
SB09512	10 mm	Blue	7	M4x.7	2.0	H9	5	
SB09513	10 mm	Yellow	7	M4x.7	2.0	H9	5	
SB09514	10 mm	Orange	7	M4x.7	2.0	H9	5	
SB09520	12 mm	White	8	M5x.8	2.5	H9	5	
SB09521	12 mm	Black	8	M5x.8	2.5	H9	5	
SB09522	12 mm	Blue	8	M5x.8	2.5	H9	5	
SB09523	12 mm	Yellow	8	M5x.8	2.5	H9	5	
SB09524	12 mm	Orange	8	M5x.8	2.5	H9	5	
SB09530	14 mm	White	10	M6x1.0	3.0	H9	5	
SB09531	14 mm	Black	10	M6x1.0	3.0	H9	5	
SB09540	15 mm	Black	6	M6x1.0	3.0	H9	5	
SB09550	16 mm	Black	10	M8x1.25	3.0	H9	5	

Material: Body: Acetal Ball: Stainless Steel Maximum Operating Temperature: 160°F (70°C)

Maximum Pressure: 150 PSI (10 bar)

WE RESERVE THE RIGHT TO CHANGE SPECIFICATIONS WITHOUT NOTICE OR OBLIGATION.



RATED TO 1500 PSI (100 BAR)

PrestoPort™



HIGH PRESSURE, PRESS-FIT PORT ADAPTORS

- Converts low pressure **ScrewBall** type ports to high pressure fixed, threaded ports

DIMENSIONS IN MILLIMETERS (except as noted)

Part No.	Nominal Dia "D"	Thread "B"	Length "A"	C	Pkg Qty	Configuration
PP24086	8mm	M6x1	6.0	0	5	
PP24106	10mm	M6x1	6.0	0	5	
PP24126	12mm	M6x1	6.0	0	5	
PP24121	12mm	1/8 NPT/BSPT	6.0	0	5	
PP24146	14mm	M6x1	7.1	1.0	5	
PP24141	14mm	1/8 NPT/BSPT	6.0	0	5	
PP24156	15mm	M6x1	7.1	1.0	5	
PP24151	15mm	1/8 NPT/BSPT	6.0	0	5	
PP24166	16mm	M6x1	7.1	1.0	5	
PP24161	16mm	1/8 NPT/BSPT	6.0	0	5	

Material: Brass **Maximum Pressure:** 1500 PSI (100 bar) **Maximum Operating Temperature:** 300°F (150°C) ***Hole Tolerance:** H9

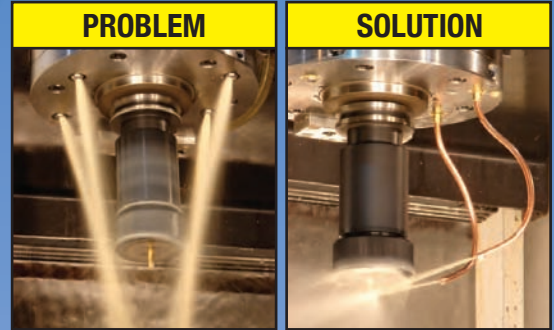

Original equipment **ScrewBall**-type nozzles often can't reach the cutting tool, and can move out of position or blow out under high pressure

PrestoPorts are easy to install and provide many options for routing high pressure coolant to the cutting tool (shown here with **Extension Tubes** - see page 17)

Installation and Removal Tools	
M6 Installation Tool Part No. IT21225 Use to Install all M6 (Thread 'B') PrestoPorts	
NPT/BSPT Installation Tool Part No. IT21230 Use to install all 1/8 NPT/BSPT (Thread 'B') PrestoPorts	
Slide Hammer Kit Part No. SH21306 Use to remove PrestoPorts and original equipment nozzles. Includes adaptors to fit M3.5, M4, M5, M6 and 1/8 NPT/BSPT	



Check Valves

- Ideal for horizontal and vertical machining centers
- Stops drain-down of coolant lines between tool changes
- Eliminates delay of coolant flow, preventing dry cutting

DIMENSIONS IN INCHES

Part No.	Configuration	Pkg Qty
CV19005		1
CV19010		1
CV19015		1

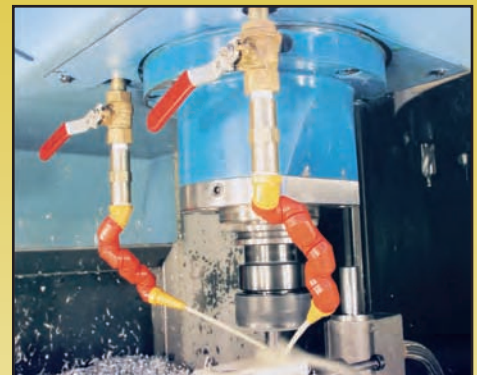

QPM Check Valves dramatically speed up coolant response time in this machining center application.

Material: Brass **Cracking Pressure:** 1 psi (.07 bar)
Maximum Pressure: 500 psi (33 bar)
Maximum Operating Temperature: 160°F (70°C)
Recommended Coolant Filtration: 100 microns

NOTE: Use **DualFit** nipples (page15) to adapt to BSPT ports



Manifold

■ Ideal for adding multiple nozzles on horizontal and vertical machining centers.

DIMENSIONS IN INCHES

Part No.	Configuration
MF17100	

NOTE: Assembly includes manifold, pipe union, 2 DualFit nipples and 7 pipe plugs.



QPM Manifolds enable 6 SwivelMax nozzles (see page 20) to be used in this face milling operation.

Maximum Pressure: 500 psi (33 bar)

Maximum Operating Temperature: 160°F (70°C)

Material: Manifold: Aluminum (anodized) Union: Brass
 Plugs: Plated Steel Nipples: Brass



Ball Valves



■ Compact design is ideal for a wide variety of machining applications.

■ Use with water-based coolants, oil or air (also vacuum applications)

■ Corrosion resistant chrome-plated brass ■ Teflon Seals ■ Rated to 250 psi (16 bar) max

DIMENSIONS IN INCHES (except as noted)

Part No.	Pipe Thread	L	N	H	"B" Hex	Flow Dia "d"	Handle Color	Pkg Qty	Configuration
BV19401	1/8 NPTF	1.45	.86	.74	14mm	.21	Blue	2	
BV19402	1/4 NPTF	1.70	.86	.74	14mm	.21	Blue	2	
BV19403	3/8 NPTF	1.89	.92	.74	18mm	.31	Blue	2	
BV19411	1/8 BSPT	1.42	.86	.74	14mm	.21	Red	2	
BV19412	1/4 BSPT	1.70	.86	.74	14mm	.21	Red	2	
BV19413	3/8 BSPT	1.81	.92	.74	18mm	.31	Red	2	

Material: Body: Chrome-plated Brass Seals: Teflon **Max Pressure:** 250 psi (16 bar) **Maximum Operating Temperature:** 175°F (80°C)



ChuckPuck™

**Contact Us
for Custom
Orders!**



FLEXIBLE FOAM DISK FOR PLUGGING LATHE CHUCK THROUGH-HOLES

- Keeps swarf and coolant from accumulating in the spindle bore
- Reduces vibration
- Reduces wear on chuck and spindle
- Improves roundness and concentricity
- Fire retarded for safety

DIMENSIONS IN MILLIMETERS

Part No.	Nominal Size (Free Dia.)	Best Fitting Chuck Bore	Min. Bore	Max. Bore	Pkg Qty
CP12035	35 mm	33 mm (KITIGAWA B205, BT205)	30 mm	34 mm	2
CP12048	48 mm	45 mm (KITIGAWA B206, BT206)	42 mm	47 mm	2
CP12055	55 mm	52 mm (KITIGAWA B208, BT208, BB208)	49 mm	54 mm	2
CP12070	70 mm	66 mm (KITIGAWA BB208)	62 mm	68 mm	2
CP12080	80 mm	75 mm (KITIGAWA B210, BT210)	72 mm	78 mm	2
CP12086	86 mm	81 mm (KITIGAWA BB210)	76 mm	83 mm	2
CP12097	97 mm	91 mm (KITIGAWA B212, BT212)	87 mm	94 mm	2
CP12107	107 mm	100 mm (KITIGAWA B215)	97 mm	104 mm	2
CP12113	113 mm	106 mm (KITIGAWA BB212)	100 mm	109 mm	2



Material: Flame-resistant neoprene foam

Ordering Information

Measure your chuck bore and order the nominal diameter to suit. (Your chuck bore must be between the max. and min. bore sizes). Contact us for custom sizes

*ChuckPucks install easily.
Just squeeze them into the chuck hole.*



BorePlug™



PLUGS FOR BORING BAR HOLDERS

- Prevents chip accumulation in empty boring bar holders
- Prevents loss of clamping screws
- Prolongs toolholder life

DIMENSIONS IN INCHES (except as noted)

Part No.	Nominal Dia "D"	Length "L"	Diameter "A"	Width "B"	Pkg Qty
BP20100	1 inch	2.75	1.44	.25	1
BP20125	1 1/4 inch	2.75	1.69	.25	1
BP20150	1 1/2 inch	2.75	1.94	.25	1
BP20200	2 inch	2.75	2.44	.25	1
BP20025	25 mm	2.75	1.44	.25	1
BP20032	32 mm	2.75	1.69	.25	1
BP20040	40 mm	2.75	1.94	.25	1
BP20050	50 mm	2.75	2.44	.25	1

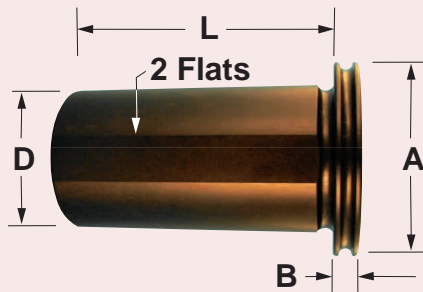

BorePlugs prevent swarf accumulation and associated damage in non-active boring bar holders.

Material: Aluminum (Hardcoat Anodized)

Visit us on the web: www.qpmproducts.com



Coolant Nozzles

QPM Products is **Your** Coolant Nozzle Specialist

We manufacture coolant nozzles for use on CNC Lathes, Machining Centers, Grinders, Screw Machines, Manual Mills and assorted production equipment. Starting in 1996 with our original **TurretJet** nozzle, we now offer a wide variety of coolant nozzles and related accessories engineered to improve your production processes. We are continually listening to and working with customers to find solutions to their coolant delivery problems. We supply a variety of spherical-element coolant nozzles to many Original Equipment Tooling & Machine Tool Builders World-Wide. If you build special purpose tooling, transfer machines, screw machines, VDI tools, live lathe tooling, dedicated production equipment, CNC machine tools or other equipment or machines, you may be able to incorporate one of our standard nozzles into your designs, or let us engineer a nozzle that suits your specific application.

We aim to please!

Look Inside For Your Coolant Nozzle Solution

ORDERING INFORMATION:

QPM coolant nozzles are sold through finer industrial supply companies worldwide.

Call toll-free: 800-711-9933 in Canada and USA or direct: 250-549-2320

for the name and number of a distributor in your area.

Our hours are 7:00am - 4:30pm, Pacific time, Monday through Friday.

Thank-you for Your Support & Business!

Distributed by:

QPM Products

Corporation

Unit #2-740 Fairweather Road

Vernon, BC Canada V1T 8T9

PRSRST STD
U.S. POSTAGE PAID
OROVILLE, WA
PERMIT NO. 29